

# Application Note 57-2

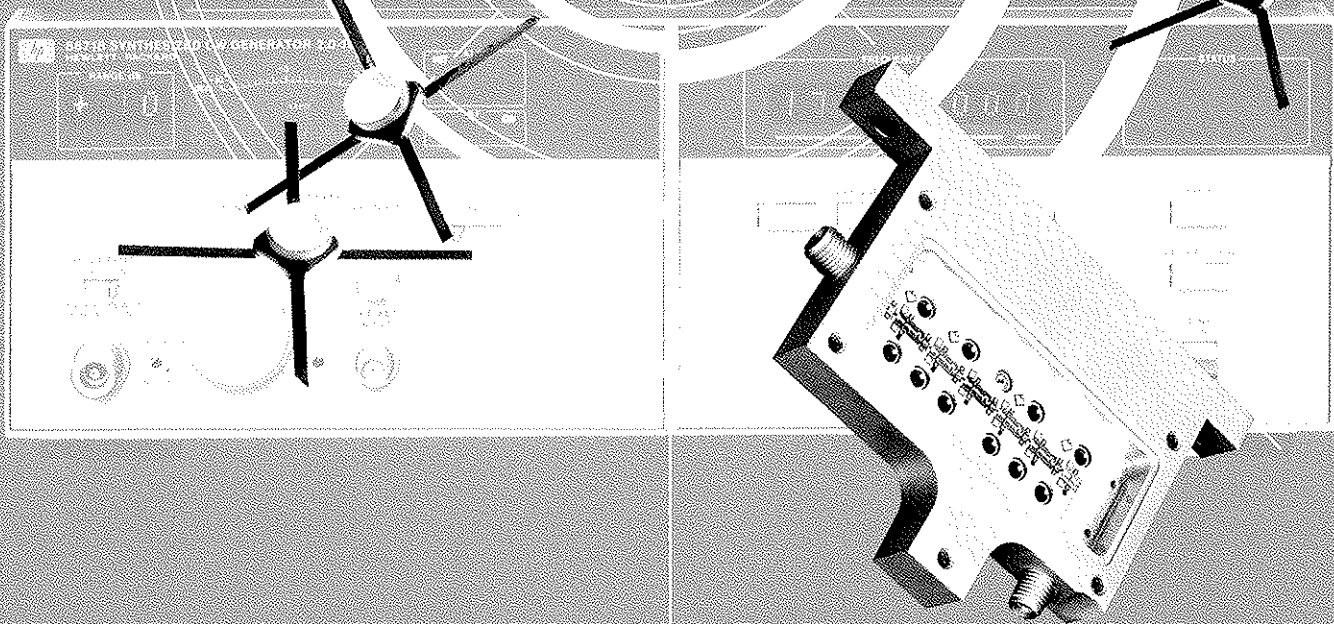

## Noise Figure Measurement Accuracy

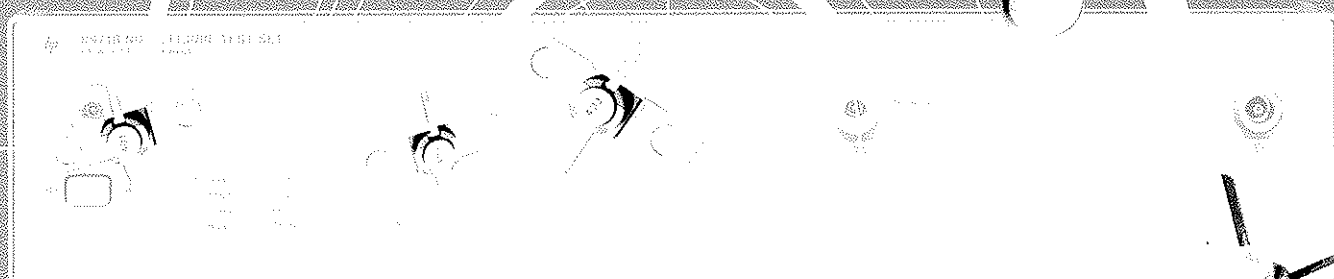
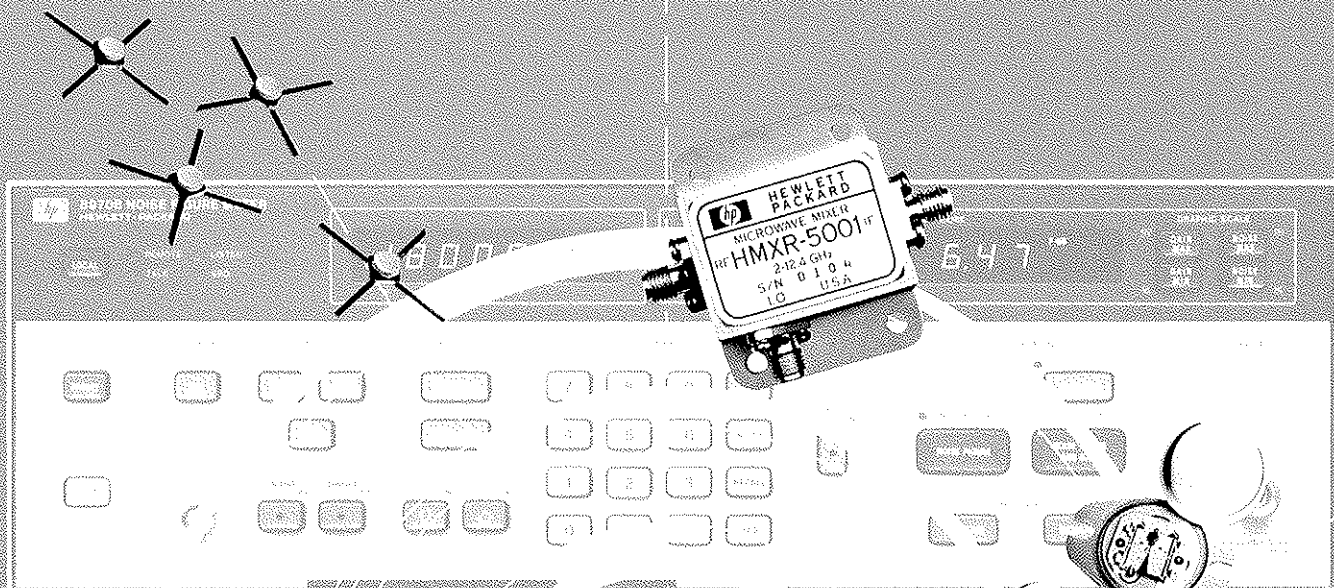

# Table of Contents

---

## Chapter 1

Introduction	5
Accurate noise figure measurements mean money	5
What will reading this note do for you?	5

## Chapter 2

What factors affect noise figure measurement accuracy?	7
Sources of error that can be eliminated	7
Sources of error that cannot be eliminated	12

## Chapter 3

Methods to calculate accuracy	13
Cascade noise figure accuracy equation	13
Measurement simulation method	14

## Chapter 4

A practical look at noise figure accuracy	15
The uncertainty versus measurement system noise figure (NF2) curve	15
Noise figure accuracy misconceptions	16

## Chapter 5

Improving measurement accuracy	18
1. Eliminate all removable errors	18
2. "Increase" device gain	18
3. Reduce measurement system noise figure (NF2)	18
4. Reduce individual uncertainties	20

## Appendix

Amplifier and transistor curves	21
Mixer and receiver curves	26

### Accurate noise figure measurements mean money

Anyone involved in the low-noise microwave business knows that noise figure is a "money number." When measuring and specifying noise figure, the more accurate a noise figure measurement is, the smaller the uncertainty guardband needed on the noise figure specification. The smaller the uncertainty guardband, the lower the noise figure specification. The lower the noise figure specification the higher the price charged.

Low-noise device and system manufacturers want accurate noise figure measurements for higher production yields. If a manufacturer of 2 dB noise figure amplifiers measures to an accuracy of .5 dB, the amplifiers must measure at most 1.5 dB to be sure the customer gets 2 dB. If the measurement accuracy can be tightened to 0.2 dB, amplifiers measuring 1.8 dB can be shipped.

There are other reasons why accurate noise figure measurements are important. In addition to improved yield, manufacturers also want accurate noise figure measurements so they can price their product higher. Users of low-noise devices and systems want accurate measurements to verify they get the performance they paid for.

Although accurate noise figure measurements are very important, measurement accuracy is seldom calculated. Since many things affect a noise figure measurement, calculating accuracy is complicated and time consuming.

---

### What will reading this note do for you?

This note is designed to show you these things:

1. Many things can affect the accurate measurement of noise figure (Chapter 2).
2. You can estimate your measurement accuracy using statistically-generated curves (Chapter 3).
3. Although it appears complicated, noise figure accuracy can be practically understood (Chapter 4).
4. You can improve your noise figure measurement accuracy in a systematic way (Chapter 5).

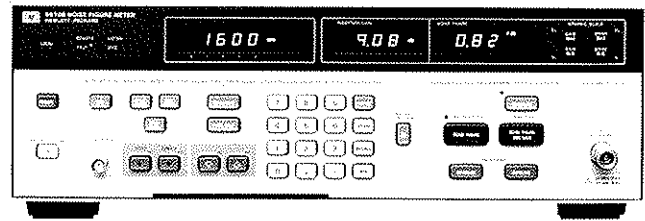

HP 8970B Noise Figure Meter (10 to 1600 MHz).

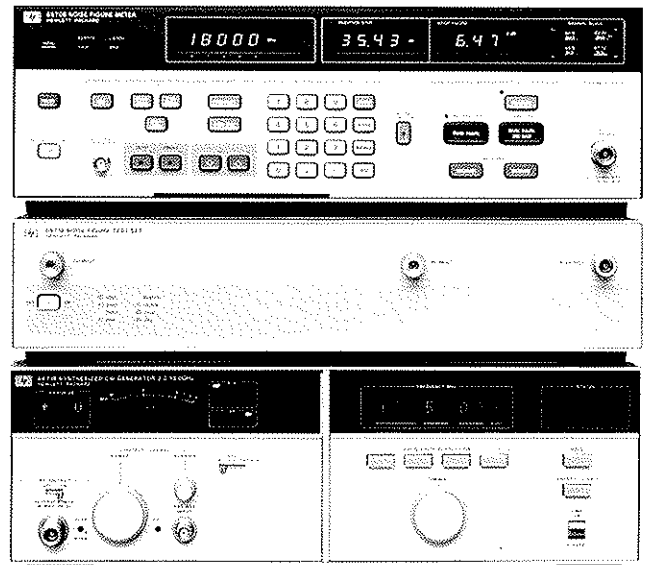

HP 8970T Noise Figure Measurement System (10 MHz to 18 GHz).

## Chapter 2 What factors affect noise figure measurement accuracy?

Because noise figure is an extremely sensitive (i.e., low-level) measurement, many more factors affect its accurate measurement than other, higher power measurements.

People measuring noise figure often make the mistake of considering only one, two, or a few factors when estimating measurement accuracy. Most often, considering only a few factors does not adequately represent true accuracy.

This chapter discusses many error sources in noise figure measurements. These error sources can be divided into two groups:

1. Sources of error that can be eliminated
2. Sources of error that cannot be eliminated

Sources of error that can be eliminated include:

- a. Dirty or bad connectors (they cause reflections and make the measurement susceptible to stray signals)
- b. EM susceptance (stray signals are measured as noise power)
- c. Impedance change between "on" and "off" (especially a problem with transistor measurements)
- d. Using insertion gain instead of available gain (this causes an error when correcting for second stage noise contribution)
- e. Noise figure and gain discontinuities in the measurement system (this can cause an error if the noise figure meter does not tune exactly to the same frequency between calibration and measurement)
- f. Jitter (the random nature of noise makes one noise reading different than the next)
- g. Double-sideband measurements (a problem with devices whose noise figure and gain response varies abruptly with frequency)

Sources of error that cannot be eliminated are combined and represent the overall accuracy of a noise figure measurement. They include:

- a. Device Noise Figure and Gain (the higher these are, the more accurate the measurement)
- b. Individual Uncertainties — mismatch, ENR, and instrumentation uncertainty (the lower these are, the more accurate the measurement)
- c. Measurement System Noise Figure (the lower this is, the more accurate the measurement)

### Sources of error that can be eliminated

Before the days of automatic noise figure meters, eliminating some sources of measurement error was difficult. If those sources were not minimized, they were simply ignored and the errors accepted. Today, with automatic meters like the HP 8970A and 8970B, many error sources are conveniently eliminated.

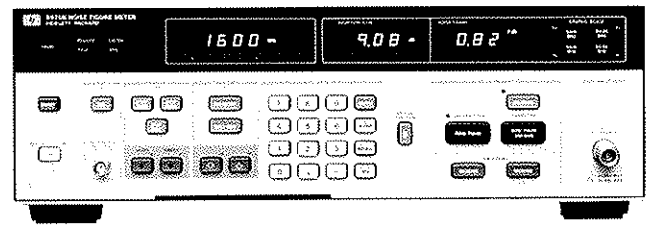

*The HP 8970B Noise Figure Meter eliminates many source of possible measurement error — noise contribution from the measurement system, noise source "off temperature" different than 290K, and compensation for losses before or after the device under test.*

There are some sources of error, however, only good measurement practice can eliminate. Here are those error sources.

**Dirty or Bad connectors:** It only takes a small amount of dirt in a connector to cause insufficient contact and allow extraneous signals to couple into the measurement. (And it only takes one dirty connector to spread dirt to many.)

If there is visible dirt on your connectors, clean them. A cotton swab and isopropyl alcohol work well.

Connectors do not last forever; they wear. Connectors with worn plating on the inner or outer conductors should be replaced. This eliminates the possibility of loose, intermittent connections.

To learn more about proper connector care, ask your HP sales representative for Service Note 346B-4 "HP 346B Noise Source RF Connector Care" (lit. no. 00346-90023).

**EM Susceptance:** Most measurements are made in environments where stray signals are present. Since few noise figure measurers have the luxury of screen rooms, many times these stray signals get coupled into the measurement. Signals emitted from computers and other instruments, fluorescent lights, local broadcast stations, etc., can get coupled into a measurement through non-threaded connectors or non-shielded cables.

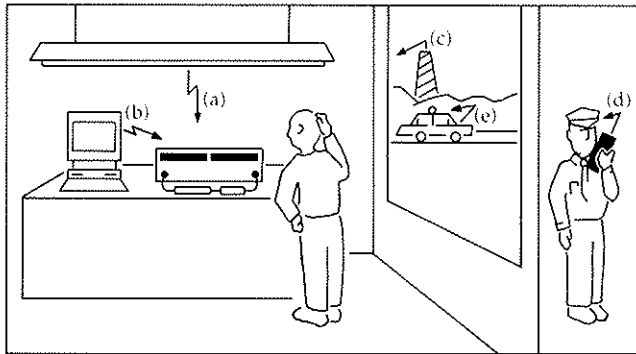

**Figure 2.1** Signals can get coupled into a noise figure measurement from many different sources (a) fluorescent lights (b) computer and other instruments (c) local tv/radio stations (d) remote paging systems (e) land-mobile radio.

Stray signals can cause several tenths of a dB difference from one measurement sweep to the next (thus appearing as an unstable measurement).

Stray signals can be easily traced. Shake the connectors in the measurement signal path and see if the noise figure changes significantly. If so, you may have a bad or dirty connector susceptible to stray signals. Another test is to attach an "antenna" (wire, etc.) to a spectrum analyzer and look for stray signals at the measurement frequency. A third test, when measuring with an HP 8970A or 8970B, is to connect to 20 MHz IF output on the HP 8970 rear panel to a spectrum analyzer. A stray signal will show up as a spike on the 20 MHz passband.

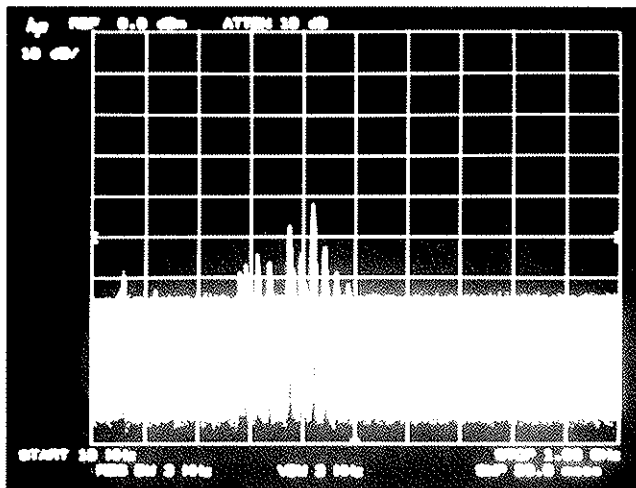

Stray signals can be seen on a spectrum analyzer.

How are stray signal problems avoided? First, use threaded connectors in the signal path whenever possible (non-threaded connectors, like BNC, are very susceptible to stray signals). Second, use double shielded cables. Third, enclose the device you are measuring in a shielding container (this is especially important if you are measuring noise figure on an open PC board).

When down-converting measurements, avoid setting your noise figure meter to intermediate frequencies (IFs) that could be radiated in your work environment. Avoid computer clock frequencies. Avoid paging system frequencies. Avoid common multiple-of-ten IFs (10, 20, 30 MHz); instead, use IFs like 26 or 27 MHz.

**Impedance change between "on" and "off" of the noise source:** When a noise source turns on, the noise-generating avalanche diode appears as a short circuit. When off, it appears as an open. Most noise sources have a matching pad at their output to minimize the on-to-off impedance difference. In some measurements, this pad does not provide sufficient matching and the small impedance difference can cause errors.

One measurement where this can cause errors is transistor characterization. In this measurement, the device-under-test (DUT) is subjected to multiple input impedances and the corresponding noise figures and gains are measured. After measuring at several input impedances, circles of constant noise figure are plotted and the impedance giving minimum noise figure is calculated. Since the input impedance needs to be carefully controlled, an on-to-off impedance change from the noise source is undesirable. Transistor characterization measurements are generally made using specially-designed noise sources with very small on-to-off impedance changes (like the HP 346A pictured below).

*The HP 346A Noise Source exhibits a much lower impedance change between on and off than normal noise sources (for transistor characterization and other impedance-sensitive measurements.)*

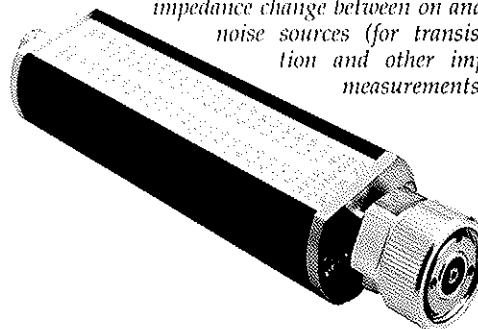

**Using insertion gain instead of available gain:** A noise figure meter measures noise figure and insertion gain<sup>1</sup>. The equation to correct for second stage contribution requires available gain<sup>2</sup>, not insertion gain. An automatic noise figure meter assuming the insertion gain IS the available gain, uses insertion gain in the second stage correction equation. This assumption results in an error.

This error is generally considered to be a mismatch error and is figured into the overall noise figure measurement uncertainty. The error can be removed by measuring the reflection coefficients of the device output ( $\Gamma_o$ ), the source ( $\Gamma_s$ ) and the load ( $\Gamma_l$ ) and substituting it into the equation for available gain

$$G_{av} = \frac{(1 - |\Gamma_s|^2) [1 - (\Gamma_o)(\Gamma_l)]^2}{(1 - |\Gamma_o|^2) [1 - (\Gamma_s)(\Gamma_l)]^2} G_{in} \quad \text{Eq. 2.1}$$

Available gain is then substituted into the cascade gain equation to calculate the noise figure of the DUT ( $F_1$ ).

$$F_1 = F_{12} - (F_2 - 1)/G_{av} \quad \text{Eq. 2.2}$$

$F_{12}$  is the combined DUT/measurement system noise figure,  $F_2$  is the measurement system noise figure. All terms in the above two equations are linear, not dB, terms. (More about Eq. 2.2 in Chapter 3.)

**Noise figure and gain discontinuities in the measurement system:** Occasionally, there is a component in the measurement system (the downconverting mixer, an amplifier, etc.) that has a noise figure or gain discontinuity (see Figure 2.2).

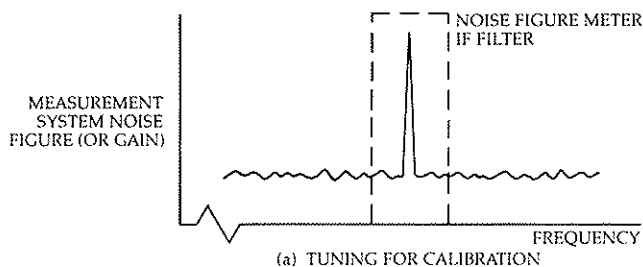

Although measurement system noise figure and gain is measured during the calibration and factored-out during the measurement, a sharp discontinuity can cause problems. If the measurement system does not perfectly tune to the same frequency from calibration to measurement, it can measure the discontinuity during calibration and not during measurement. The noise figure meter then corrects for more second stage noise than actually present. This results in a measurement error.

There are a few ways to avoid this problem. First, see that your measurement system noise figure and gain response is flat. To do this, measure system noise figure and gain in very small frequency increments (1 to 5 MHz). If the response looks fairly flat, there should be no discontinuity problems. Second, if a discontinuity is present, use a high gain, low-noise preamplifier at the measurement system input. The preamplifier reduces the noise figure contribution of the measurement system, including discontinuities. Third, calibrate at the frequencies you want to measure and approach the measurement frequency in the same direction as the calibrated frequency (i.e., from low to high frequency). This helps avoid non-repeatable tuning due to hysteresis of any YIG oscillator or YIG filter in the measurement system.

**Jitter:** All noise measurements, because of the random nature of noise, exhibit some degree of instability, or jitter. The amount of jitter is a function of the device measured (its noise figure and gain) and the design of the measuring instrument.

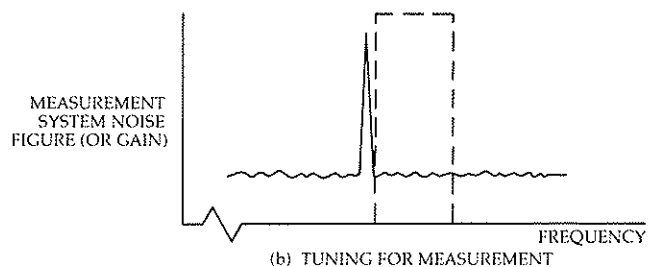

Figure 2.2 If the measurement system has noise figure or gain discontinuities, non-repeatable tuning between (a) calibration and (b) measurement can cause errors when correcting for second stage contribution.

<sup>1</sup> Insertion gain: The gain that is measured by inserting the DUT between a generator and load. The numerator of the ratio is the power delivered to the load while the DUT is inserted. The denominator, or reference power, is the power delivered to the load while the source is directly connected.

<sup>2</sup> Available gain: The ratio of power available from the output of the network to the power available from the source.

Jitter is minimized by averaging many measurements. (With the HP 8970A or 8970B, jitter can be reduced to less than .02 dB.) Averaging, or smoothing, decreases jitter at the expense of decreased measurement speed.

Since jitter can be reduced to such a small value (.02 dB), it will not be considered when we calculate accuracy. If your noise figure meter cannot minimize jitter to such a small value, you will need to add an additional jitter error term when determining uncertainty.

**Double-sideband measurements:** This section discusses down-converted microwave measurements of amplifiers and transistors (i.e., non-frequency translating devices).

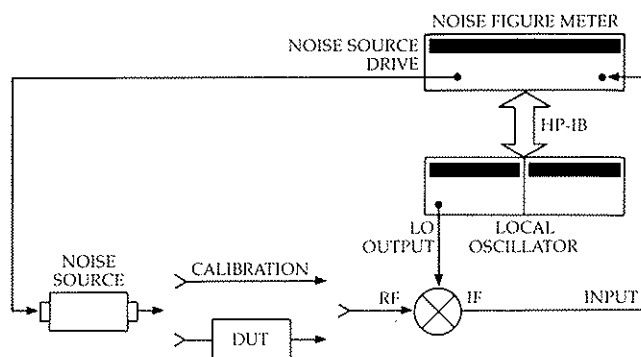

Figure 2.3 Microwave noise figure measurement set-up (double-sideband measurement).

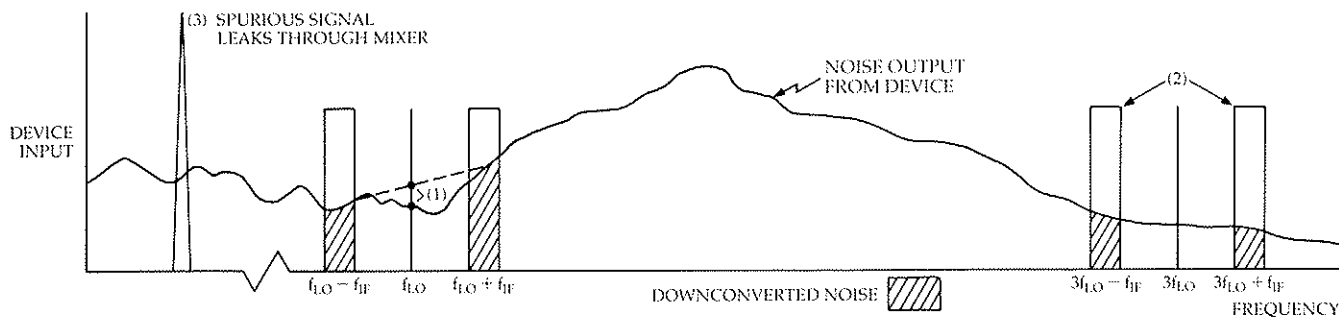

Figure 2.4 Double-sideband measurements (1) can cause sideband averaging errors, (2) allow 3rd harmonics to be down-converted and (3) allow other spurious signals to be coupled into the measurement.

When a noise bandwidth is down-converted from a microwave frequency to the tunable range of a noise figure meter, the desired noise band is not the only noise down-converted. There are two main noise bands down-converted plus possible harmonic noise bands. If a measurement system allows both main noise bands to be down-converted, it is a double-sideband (DSB) measurement system. If the measurement system prevents one sideband (commonly known as the image band) and allows the other noise sideband (the desired band) to be down-converted, it is a single-sideband (SSB) measurement system. Because DSB measurements allow more than one band of noise to be down-converted, errors may be introduced in the measurement.

One source of error in DSB measurements involves the two main down-converted noise bands ( $f_{LO} + f_{IF}$  and  $f_{LO} - f_{IF}$ ). The noise figure meter, tuned to the IF, measures the combined noise from the two down-converted frequencies. The noise figure meter does not "know" the noise it measures is from two bands. Because of this, the noise figure value displayed is an average of the two down-converted bands. If the device response between the two sidebands is not linear, the average value can differ from the actual value. (see (1) in Figure 2.4). (If the device measured has a flat frequency response, like a broadband amplifier, there will probably not be much sideband-averaging error.)

The  $f_{LO} \pm f_{IF}$  noise sidebands, although dominant, are not the only down-converted noise bands a DSB system measures. A down-converting mixer generates harmonics of the local oscillator ( $2f_{LO}$ ,  $3f_{LO}$ , etc.). In double balanced mixers, the even harmonics ( $2f_{LO}$ ,  $4f_{LO}$ , etc.) are usually well suppressed; the odd harmonics ( $3f_{LO}$ ,  $5f_{LO}$ , etc.) are not. As a result, odd harmonics mix with and down-convert RF noise just like the fundamental LO frequency (see (2) in **Figure 2.4**). The 3rd harmonic is the dominant odd harmonic — its mixing products can be as large as only 10 dB down from the fundamental responses. As in the case of image noise, these signals are averaged into the final result and, if large enough, cause errors.

Other spurious signals can also be coupled into a DSB measurement through the IF and cause measurement errors (see (3) in **Figure 2.4**).

Three aspects of a DSB measurement can cause problems when characterizing transistors. First, since two different input frequencies are being measured in a DSB measurement, characterization is taking place at two different input impedances. Second, the physical distance between the device and tuner causes a phase shift as the two noise sidebands travel from the device, reflect from the tuner and return to the device input (since in a transistor characterization measurement, you want to characterize impedance in terms of phase as well as magnitude, a phase measurement error will result). Third, an adjustable tuner creates a sharp noise figure (or gain) variation. Due to its averaging nature, a DSB measurement will tend to smooth out the dip (or peak), giving an inaccurate reading.

Single-sideband measurements eliminate double-sideband problems by pre-selecting the desired noise sideband before it is down-converted. This way, all undesirable signals are removed before they are down-converted.

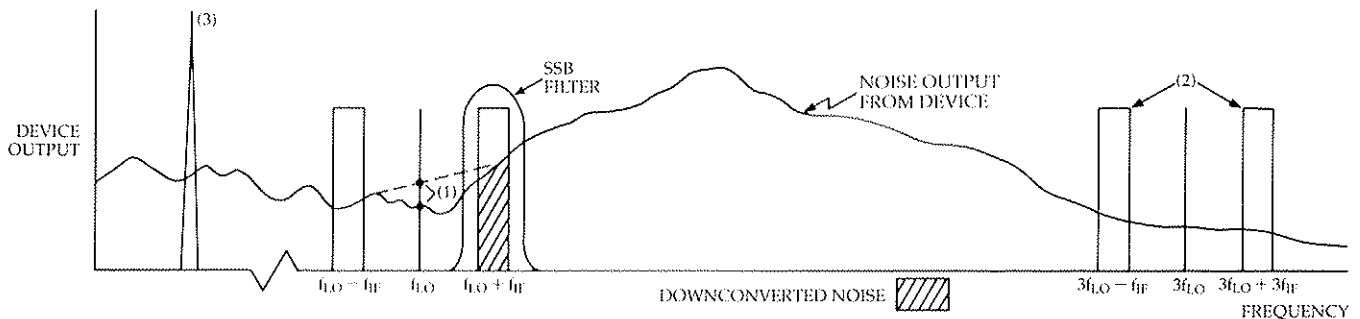

**Figure 2.5** A single-sideband filter gets rid of double-sideband problems: (1) sideband averaging errors, (2) 3rd order harmonics and (3) other spurious signals.

Single-sideband measurements are made either with a fixed filter (for narrowband systems), a tunable YIG filter (like the one in the HP 8971B pictured below for broadband systems), or an image-reject mixer. Filtering only the desired measurement band frequency to be downconverted (see **Figure 2.5**); an image reject mixer does not eliminate 3rd order harmonic mixing or spurious responses.

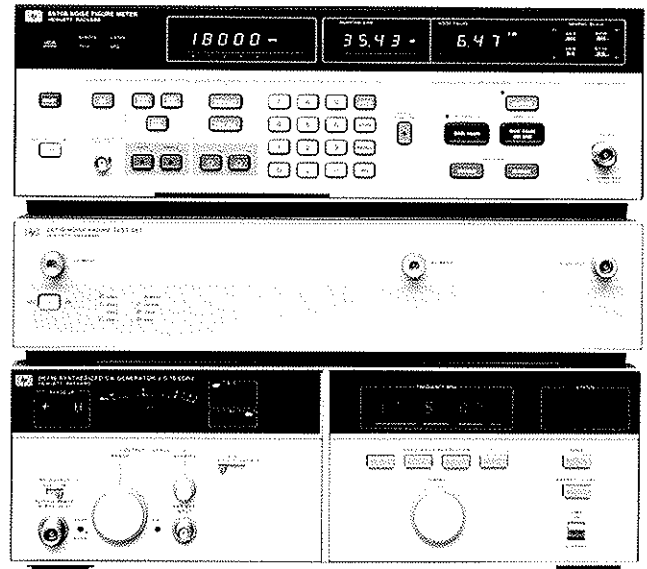

The HP 8971B Noise Figure Test Set (middle instrument) uses a temperature-compensated YIG-tuned filter to make single-sideband measurements. In the HP 8970T system configuration pictured here, the HP 8970B Noise Figure Meter (top) acts as the controller for both the HP 8971B and HP 8671B Synthesized CW Generator (bottom).



---

Suppliers and users of low noise devices all want a standard way to measure noise figure so their answers are accurate and agree. The accuracy of a DSB measurement depends on the flatness of the DUT noise figure and gain response; the accuracy of a SSB measurement is independent of DUT flatness. This makes SSB the only standard way to make down-converted noise figure measurements.

---

### Sources of error that cannot be eliminated

There are a few noise figure measurement error sources that cannot be eliminated. (They can be reduced, but not eliminated.) Listed below are these errors. In Chapter 3, a noise figure measurement accuracy is calculated from these errors.

These non-removable factors can be divided into three groups:

1. **Device under-test (DUT) noise figure and gain**

2. **Individual uncertainties:**

**Noise Figure and Gain Instrumentation**

**uncertainty:** Noise figure instrumentation uncertainty is typically the linearity of the noise figure meter's detector. Gain instrumentation uncertainty is typically the detector and attenuator linearity of the meter. They are given as noise figure meter specifications.

**ENR uncertainty:** The uncertainty between the calibrated and actual (National Bureau of Standards) value. This is an uncertainty only given for calibrated points; it does not take into account ENR variation with frequency between the calibrated points.

**Mismatch uncertainty:** There are typically three: (1) mismatch between the noise source and DUT input (2) mismatch between the DUT output and the measurement system input and (3) mismatch between the noise source output and the measurement system input (during calibration).

3. **Measurement system noise figure:** The measurement system noise figure includes not only the noise figure meter itself, but also any external devices used for downconversion and filtering. It typically ranges from 4 to 28 dB.

Calculating noise figure accuracy is not a simple, straight-forward calculation. There are several reasons for this. One, as stated previously, many sources of error affect noise figure measurement accuracy (ENR uncertainty, instrumentation uncertainty, mismatch uncertainty, etc.). Two, the noise power measurement results are not readily available from a noise figure meter to let someone calculate noise figure accuracy based on the power measurements. Three, the results that are available (DUT noise figure and gain, measurement system noise figure) are dependent on one another; the sensitivity of how one variable affects another needs to be taken into account.

This chapter discusses two methods of calculating measurement accuracy.

The first method is the cascade noise figure equation method. This method provides good intuitive understanding of noise figure accuracy but makes simplifying assumptions that are not always valid; we will use it as an instructional tool.

The second method is the statistically-based measurement simulation method. This method provides a better representation of noise figure measurement accuracy than the cascade method. Several statistically-generated uncertainty curves are provided in the appendix to help you estimate the accuracy of your measurement. (These curves are Uncertainty versus DUT Noise Figure and Gain curves; the curves we will describe in this chapter are Uncertainty versus Measurement System Noise Figure curves. Uncertainty versus Measurement System Noise Figure curves are useful in explaining noise figure measurement accuracy theory. Uncertainty versus DUT Noise Figure and Gain curves are more useful in calculating a real-life measurement accuracy because while DUT noise figure and gain vary a lot in a typical measurement situation, measurement system noise figure does not.)

### Cascade noise figure accuracy equation

A noise figure meter measures the combined noise figure of the DUT and the measurement system. (See Figure 3.1.)

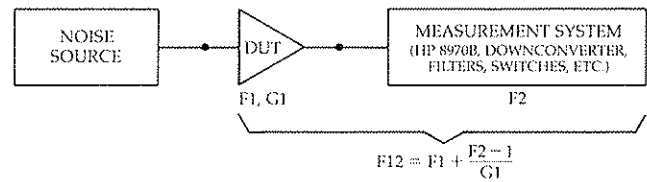

Figure 3.1 Typical noise figure measurement setup. Device and measurement system noise figures combine according to the cascade gain equation.

To determine the noise figure of the DUT alone, an automatic noise figure meter (like the HP 8970B) subtracts the noise contribution of the measurement system (i.e., the HP 8970B itself) from the cascaded DUT/measurement system noise figure<sup>3</sup>:

$$F_1 = F_{12} - \frac{F_2 - 1}{G_1} \quad \text{Eq. 3.1}$$

$F_2$ , the measurement system noise figure, is measured during calibration.  $F_{12}$  is the DUT-plus-measurement-system measurement.  $G_1$  is the device available gain.  $G_1$  is measured by taking a noise power between the measurement ( $F_{12}$ ) and calibration ( $F_2$ ). (These are linear, not dB, terms.)

The measurement of DUT noise figure ( $F_1$ ) can be thought of as a calculation based on three separate measurements —  $F_{12}$  measurement,  $F_2$  measurement, and  $G_1$  measurement. ( $G_1$  is actually not a measurement but a derivation from the  $F_2$  and  $F_{12}$  measurements.) If we know how  $F_1$  varies with changes in the  $F_{12}$ ,  $F_2$ , and  $G_1$  measurements, we can calculate an overall accuracy for  $F_1$  based on how errors in each of those measurements affect  $F_1$ .

By taking the partial derivatives of  $F_{12}$ ,  $F_2$  and  $G_1$  with respect to  $F_1$  in the Eq. 3.1, we can calculate how sensitive  $F_1$  is to the three measurements. This partial-derivative equation, in dB terms, is:

$$\Delta NF_1 = \frac{F_{12}}{F_1} \Delta NF_{12} - \frac{F_2}{F_1 G_1} \Delta NF_2 + \frac{F_2 - 1}{F_1 G_1} \Delta G_1 \quad \text{Eq. 3.2}$$

Overall uncertainty,  $\Delta NF_1$ , is then calculated by squaring each item, adding them, then taking the square root (i.e., root-sum-of-squares or RSS).

<sup>3</sup> This equation is based on the cascade noise figure equation. See page 17 of HP Application Note 57-1 for more about second stage noise contribution.

The cascade noise figure accuracy equation gives a good picture of how the error-causing factors affect overall accuracy (e.g., as  $G_1$  increases, each term in the equation decrease. When the terms are then added in a root-sum-of-squares manner, you can see that overall uncertainty decreases). Eq. 3.2 is not, however, recommended when calculating accuracy — it makes the assumption that gain is a separate measurement (remember,  $G_{12}$  is only a derivation). This assumption makes the resulting uncertainty unrealistically large.

### Measurement simulation method

The measurement simulation method uses a computer to simulate probable measurement conditions. It uses those conditions to simulate probable measurement results and then calculates a realistic uncertainty based on many such simulated measurements.

The simulation method practically assumes that each source of measurement error (instrumentation uncertainty, ENR uncertainty, etc.) is distributed in a Gaussian (bell-shaped) probability distribution. The one exception is reflection coefficient phase; this is assumed to be uniformly distributed between 0 and  $2\pi$ .

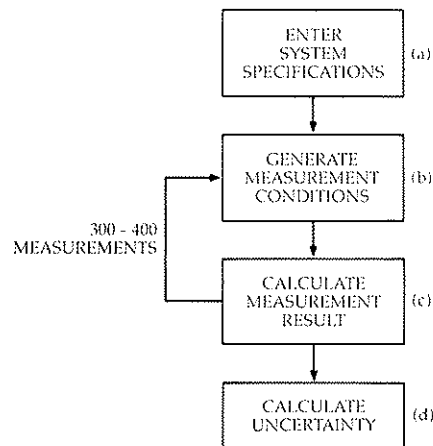

**Figure 3.2** Flow graph of measurement simulation method of calculating noise figure accuracy. (a) Programmer enters measurement system specifications into the computer. (b) Computer generates typical measurement conditions based on system specifications and a Gaussian probability distribution. (c) Computer calculates the measurement result. After 300 to 400 of these measurements, (d) the computer calculates uncertainty boundaries where 95% of the simulated measurements fall within those boundaries.

The standard deviations for the simulated measurement conditions are derived from instrument specifications. The instrument specifications are assumed to be at 3 standard deviations (this is very conservative for HP instrumentation).

The computer first generates a random variate corresponding to each measurement condition. It then determines the actual noise figure measurement result based on those conditions. After many "measurements" (300 to 400), the computer then calculates boundaries in which a certain percentage of the "measurements" lie (95% boundaries were used for the curves in the appendix). These boundaries define the measurement uncertainty.

The appendix shows several uncertainty curves generated with the measurement simulation method. If your measurement conditions are close to those of the curves, use these curves to calculate your measurement uncertainty. (Keep in mind these are uncertainty versus DUT noise figure plus gain curves, not uncertainty versus measurement system noise figure.)

The measurement simulation method gives a realistic representation of measurement accuracy. It, like the cascade noise figure method, has some drawbacks. One, it can be complicated to program and two, it can be computationally time-consuming. The curves in the appendix, however, should be sufficient in showing you the accuracy of many of your measurements.

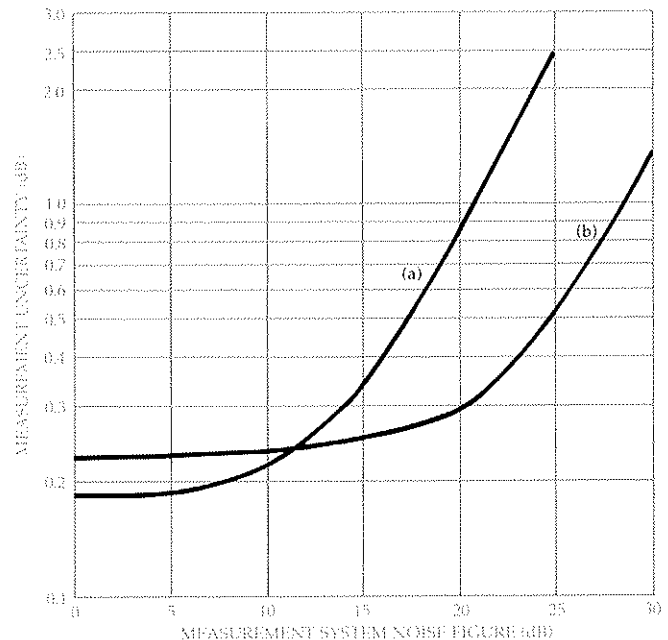

**Figure 3.3** Comparison of (a) cascade noise figure accuracy equation and (b) measurement simulation method for a typical DUT and measurement system.

This chapter discusses a number of noise figure accuracy issues on a practical level. This should give you a better understanding of noise figure measurement accuracy so you are more comfortable making and specifying the measurement.

Specifically, this chapter (1) shows a practical way to think about noise figure accuracy and (2) discusses and dispels some noise figure accuracy misconceptions.

**The uncertainty versus measurement system noise figure (NF2) curve**

A good way to get an intuitive understanding of noise figure accuracy is to study a graph. One such graph is total measurement uncertainty versus measurement system noise figure (Figure 4.1).

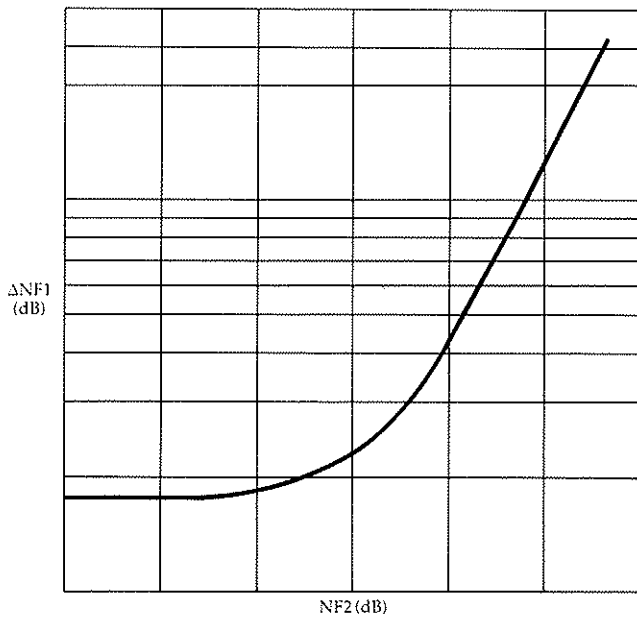

Figure 4.1 The Uncertainty ( $\Delta NF1$ ) versus Measurement System Noise Figure (NF2) Curve.

Each of the three error sources mentioned in Chapter 2 (device noise figure and gain, individual uncertainties, and NF2) affect the uncertainty curve differently.

**Device noise figure and gain:** Changing these factors shifts the curve left or right. Higher device gain and/or noise figure shifts the uncertainty curve to the right (see Figure 4.2). This means higher device gain (and/or noise figure) gives better measurement accuracy for a given NF2. In short, a device with high gain or high noise figure can be measured with greater accuracy than one with lower gain or noise figure.

As a general rule, the more device or input noise power measured, with respect to measurement system noise power, the more accurate the measurement will be. Therefore, if a device has high gain, a lot of amplified input noise will be measured; as a result, measurement accuracy will be good. If a device has a high noise figure, a lot of DUT noise will be measured; again, accuracy will be good.

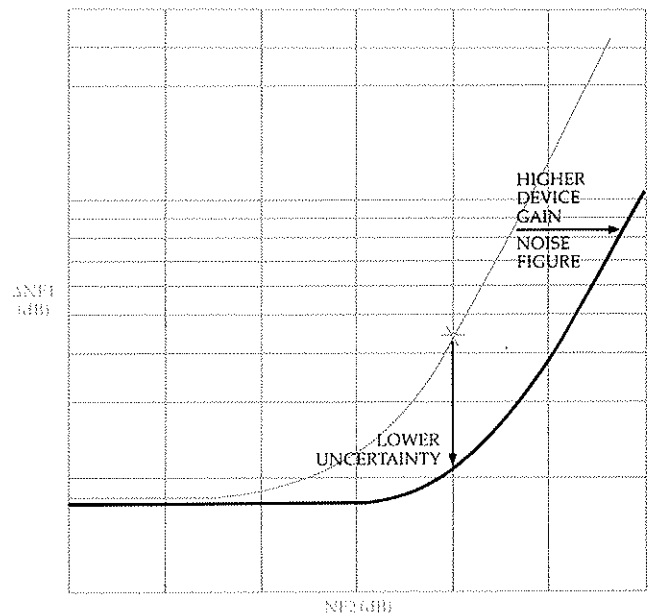

Figure 4.2 High gain or noise figure devices shift the curve to the right (lower uncertainty results).

**Individual uncertainties:** Changing the ENR, instrumentation, and mismatch uncertainties lowers or raises the uncertainty curve. (See Figure 4.3.) (Changing these uncertainties also tends to decrease or increase the curve's slope.) Measurement accuracy can be improved by lowering one or more of the individual uncertainties.

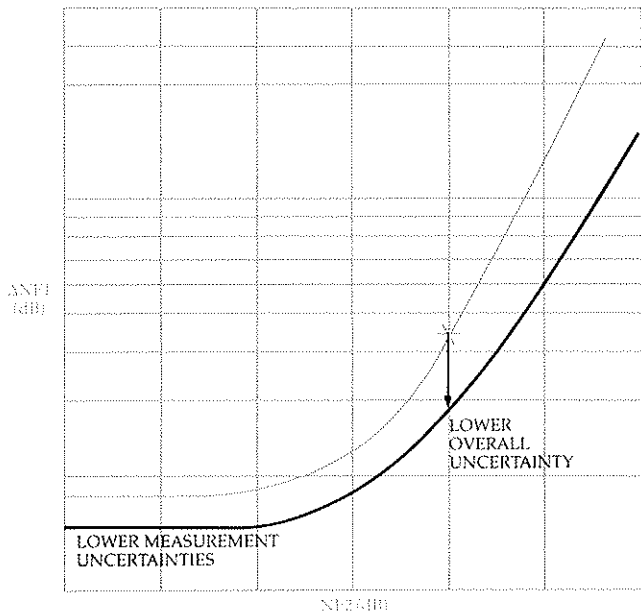

Figure 4.3 Lower ENR, mismatch, and instrumentation uncertainties shift the curve downward (lower overall uncertainty results).

**Measurement system noise figure (i.e., NF2):**

Changing the noise figure of the measurement system moves the measurement uncertainty along the curve.

Figure 4.4 shows that lowering measurement system noise figure can have a large effect on measurement

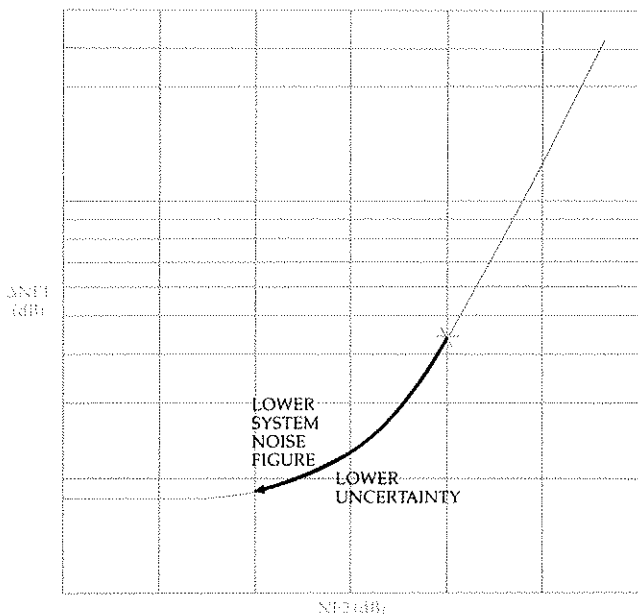

Figure 4.4 Lower measurement system noise figure (NF2) moves the uncertainty along the curve (lower uncertainty results).

accuracy, much more so than lowering the individual uncertainties. (Chapter 5 explains how to reduce measurement system noise figure.) When measuring low gain/low noise figure devices (like transistors), a low system noise figure is necessary to make an accurate measurement.

**Noise figure accuracy misconceptions**

The uncertainty versus NF2 curve does more than just give an intuitive feel of how the sources of error affect overall accuracy. It also helps to visualize accuracy in a way to clearly dispell some common misconceptions about noise figure accuracy. Here are two such misconceptions.

**“Instrumentation uncertainty is VERY significant”**

Many people measuring noise figure mistakenly consider the noise figure meter’s instrumentation uncertainty as the main indicator of measurement accuracy. The truth is that instrumentation uncertainty contributes very little to the overall measurement uncertainty.

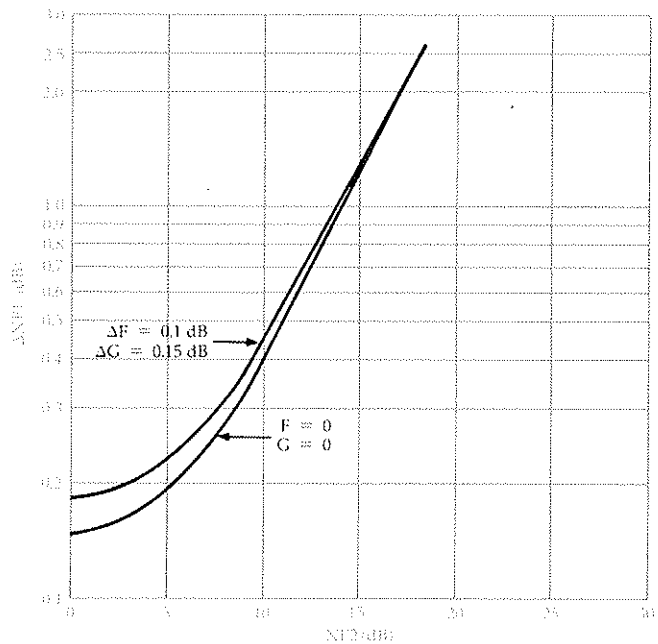

Figure 4.5 Comparison of effect of normal and zero instrumentation uncertainty on overall uncertainty.

---

The uncertainty versus NF2 curve shows how little the instrumentation uncertainty contributes to measurement inaccuracy. **Figure 4.5** compares overall measurement accuracy using the HP 8970A or 8970B instrumentation accuracy (0.1 dB) to the overall measurement accuracy if the instrumentation uncertainty were zero. For this particular DUT noise figure and gain and a NF2 of 6 dB, the difference in overall uncertainty is only about 0.03 dB (and that is comparing the HP 8970 to a perfect meter!). You can see that very little is gained in accuracy when instrumentation uncertainty is eliminated, much less just reduced.

**“Measurement system noise figure is NOT significant”**

Most people do not even consider measurement system noise figure as having an effect on their measurement accuracy. Earlier we learned that low noise/low gain devices shifted the uncertainty curve to the left. This means that even for moderate measurement system noise figures (8 to 10 dB), the total uncertainty lies on the upward slope of the curve. Reducing NF2 by several dB can improve measurement uncertainty by several tenths of a dB to a dB or two.

In every measurement, it is advantageous to minimize NF2's effect on measurement accuracy. Reducing NF2 is discussed in the next chapter.

Knowing a systematic way to improve measurement accuracy is just as important as knowing how to improve the sources of error. This chapter discusses a logical order for improving measurement accuracy:

1. Eliminate all removable errors
2. "Increase" device gain
3. Reduce NF2
4. Reduce individual uncertainties

---

### 1. Eliminate all removable errors

These factors were mentioned in Chapter 2. Refer to Chapter 2 to find out how to eliminate them.

---

### 2. "Increase" device gain

Device noise figure and gain usually cannot be changed to get a more accurate measurement. The DUT can be "chosen," however, for best possible measurement accuracy. In a receiver front end, the downconverting mixer is followed by an IF amplifier. Typically the combination mixer/IF amplifier noise figure is the important noise figure specification of the receiver. Because of the added IF amplifier gain, a better measurement uncertainty results if the mixer/IF amplifier combination is measured, rather than the mixer alone.

As a general rule, for a more accurate measurement, "choose" the device under test for as much gain as possible.

---

### 3. Reduce measurement system noise figure (NF2)

In many cases, reducing NF2 improves accuracy more than any of the other steps.

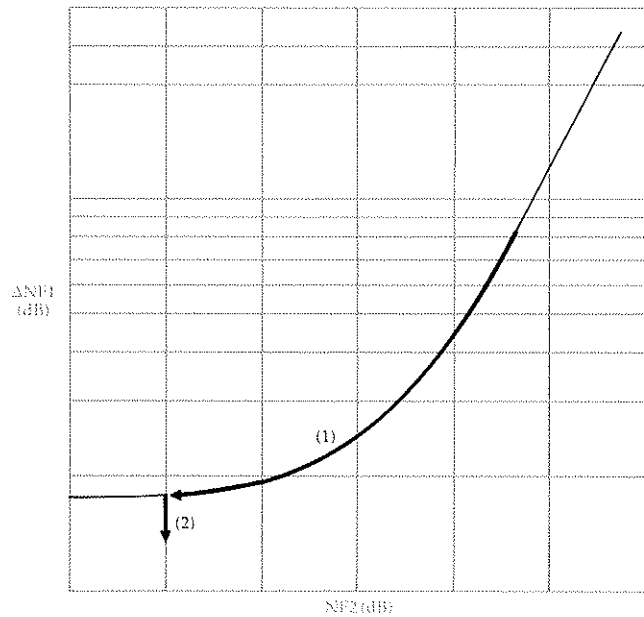

Figure 5.1 Uncertainty versus NF2 graph showing systematic approach to measurement accuracy improvement: (1) reduce (minimize) NF2 then (2) reduce individual uncertainties.

As NF2 gets smaller, the uncertainty versus NF2 curve flattens out to a base. If NF2 is reduced so the uncertainty lies on the curve base, NF2's effect on accuracy has been virtually negated.

Here is a simple approximation that helps determine the largest value NF2 can be and still be on the curve base:

$$NF2 \leq (NF1 + G1) - 5 \text{ dB}^1 \quad \text{Eq. 5.1}$$

(This approximation is determined by observation of the uncertainty curves in the appendix.)

NF2 can be reduced to this minimized level with a low noise preamplifier in the measurement system. If your current NF2 meets the above condition, your uncertainty lies on the curve base and a preamplifier is not needed. It is important to note, however, that even if the measurement system has a noise figure that seems low (6 dB, for example), the minimized NF2 value depends on the noise figure and gain of the DUT.

<sup>1</sup>In other HP documentation, this equation uses a 15 dB instead of a 5 dB difference. The 15 dB difference is derived, by observation, from the cascade noise figure accuracy equation; the 5 dB difference is derived, by observation, from the measurement simulation curves in the appendix.

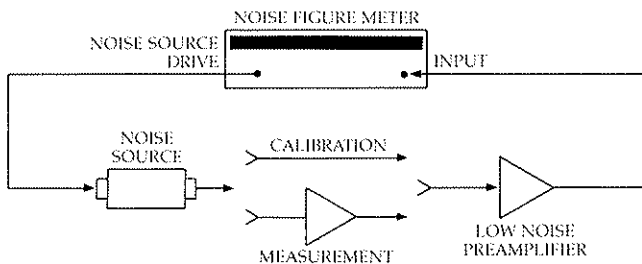

Figure 5.2 Measurement system set-up with preamp.

Next, once the minimized NF2 is calculated, calculate the noise figure and gain of the preamplifier needed.

A preamplifier will lower F2 (NF2) according to the cascade gain equation:

$$F_{2_{\text{reduced}}} = F_{pa} + \frac{F_{2_{\text{current}}} - 1}{G_{pa}} \quad \text{Eq. 5.2}$$

where  $F_{pa}$  and  $G_{pa}$  are the preamplifier's noise figure and gain,  $F_{2_{\text{current}}}$  is the current measurement system noise figure and  $F_{2_{\text{reduced}}}$  is the new (reduced) measurement system noise figure. (All terms in this equation are linear, not logarithmic.)

The first step in choosing a preamplifier is choosing its noise figure. Eq. 5.2 shows that  $F_{2_{\text{reduced}}}$  can never be lower than the preamplifier noise figure ( $F_{pa}$ ). Therefore, if NF2 needs to be reduced to 3 dB ( $F_{2_{\text{reduced}}} = 2$ ), a less-than 3 dB noise figure preamplifier is needed.

Once the preamplifier noise figure is determined, its gain is calculated according to the cascade gain equation mentioned above:

$$G_{pa} = \frac{F_{2_{\text{current}}} - 1}{F_{2_{\text{reduced}}} - F_{pa}} \quad \text{Eq. 5.3}$$

The noise figure and gain of the preamplifier can also be determined graphically (see Figure 5.3). To use the graph:

1. Choose the preamplifier's noise figure on the left side of the graph (i.e., choose a  $NF_{pa}$  curve lower than  $NF_{2_{\text{reduced}}}$ ).
2. Follow the  $NF_{pa}$  curve to the right until it intersects with the grid line representing the  $NF_{2_{\text{reduced}}}$  value.
3. Follow the vertical grid line at the intersection up (or down) until it intersects with the  $NF_{2_{\text{current}}}$  on the diagonal lines.
4. Follow the intersecting horizontal grid line to the right to get the preamplifier gain needed.

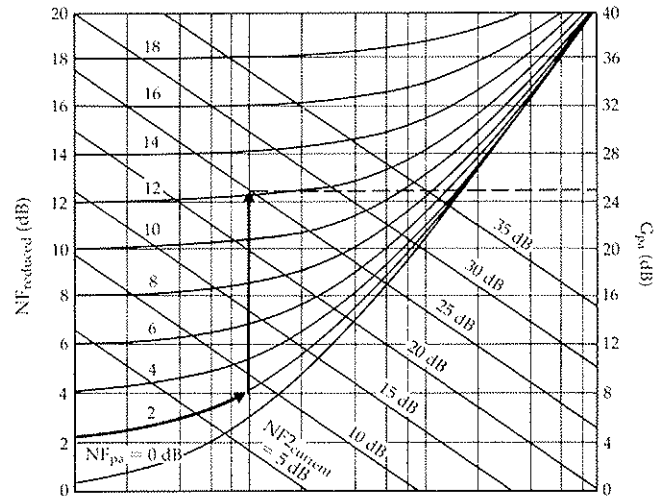

Figure 5.3 Graph to calculate preamp noise figure and gain. (Procedure for use is given in text.) Example shown: To reduce  $NF_{2_{\text{current}}}$  (25 dB) to  $NF_{2_{\text{reduced}}}$  (4 dB), a 2 dB noise figure, 25 dB gain preamplifier is needed.

If you already have a preamplifier, you can use the graph in the opposite direction to calculate how much it will reduce the NF2.

A few more words about reducing measurement system noise figure. First, always try to reduce measurement system noise figure, even if your preamplifier does not reduce it to the curve's base (every little bit helps). Second, if you have two devices with gain, use one as a measurement system preamplifier and measure the other. Third, the preamplifier input impedance becomes the measurement system's input impedance. A preamplifier's input match is typically not very good. Improving mismatch is part of the next topic.

There is an upper limit to the preamplifier gain in a measurement system. Too much power at the noise figure meter input could overload it, causing inaccurate measurements or damage. The input power to the noise figure meter is:

$$P_{in} = -174 \text{ dBm/Hz} + \text{ENR}(\text{dB}) + 10 \log(\text{BW}_{\text{preamp}} \text{ Hz}) + \text{NF1}(\text{dB}) + \text{G1}(\text{dB}) + \text{G}_{\text{preamp}}(\text{dB}) \quad \text{Eq. 5.4}$$



In the case of the HP 8970T,  $P_{in}$  should not exceed the  $-20$  dBm maximum operating limit. As an example, a 6-18 GHz, 20 dB gain system preamplifier is used in an HP 8970T measurement system to measure a 5 dB noise figure, 20 dB gain, 6-18 GHz amplifier. The noise source has 15.2 dB ENR.

$$P_{in} = -174 \text{ dBm/Hz} + 15.2 \text{ dB} + 10 \log \\ (18 \times 10^9 - 6 \times 10^9 \text{ Hz}) \\ + 5 \text{ dB} + 20 \text{ dB} + 20 \text{ dB}$$

$$P_{in} = -13 \text{ dBm}$$

This power is higher than the HP 8970T input rating. Use a 10 dB pad at the preamplifier output to reduce the HP 8970T's input power below its maximum operating limit.

Another preamplifier specification needing consideration is the gain compression point. The preamplifier's gain compression should be 9 dBm or greater. This helps keep the measurement system linear, preventing further measurement errors.

Preamplifiers meeting the specifications outlined in this section can be purchased from several manufacturers. Two such manufacturers are: Avantek, in Santa Clara, CA (408-727-0700) and Miteq, in Hauppauge, NY (516-543-8873).

---

#### 4. Reduce individual uncertainties

Once NF2 is reduced to the uncertainty curve base, measurement accuracy is further improved by reducing the individual uncertainties. (See Figure 5.1.)

**Reduce Mismatch (add an isolator to measurement system input):** An isolator at the measurement system front end reduces mismatch and, in turn, measurement uncertainty. An isolator between the noise source and DUT also helps to reduce measurement uncertainty but may introduce other problems (like out of band resonances and reflections from lower quality connectors).

Since an automatic noise figure meter cannot calibrate out loss before the DUT, the isolator loss needs to be compensated during the measurement.

Pads (attenuators) also reduce mismatch. Pads, however, have high noise figures. The accuracy improvement gained in improved match is often lost in NF2 degradation. An isolator provides a match as good or better than a pad with lower noise contribution.

**Reduce ENR uncertainty (have the noise source calibrated as accurately and as often as possible):** The HP 346 noise source you buy is 2 or 3 calibration generations removed (depending on frequency) from the National Bureau of Standards. Each level of calibration adds a small amount of uncertainty.

Noise source ENR uncertainty can be improved by eliminating one or more calibration generations. HP Standards Lab offers noise source re-calibration services. This typically eliminates one calibration generation. (Contact the nearest HP service center for more details.)

The National Bureau of Standards also has noise source calibration services. For more details, contact the NBS directly.

---

#### Summary

This note has shown you that:

1. Many things can affect the accurate measurement of noise figure (Chapter 2).
2. You can estimate your measurement accuracy using statistically-generated curves (Chapter 3).
3. Although it appears complicated, noise figure can be practically understood (Chapter 4).
4. You can improve the accuracy of your noise figure measurement in a systematic way (Chapter 5).

This application note was designed to give you the information needed to maximize your noise figure measurement time and money. Above all, Hewlett-Packard wants you to make the most accurate, and profitable, noise figure measurements possible.

# Appendix

The following are Uncertainty versus DUT Noise Figure and Gain graphs. (DUT noise figure and gain is simply the dB sum of the device-under-test noise figure and gain.) All curves assume an HP 346 Noise Source is used (SWR<sub>out</sub> = 1.25; ENR uncertainty = .1 dB). They also assume that an HP 8970A or 8970B Noise Figure Measurement System, or HP 8970T Noise Figure Measurement System, or HP 8970B Noise Figure Meter, 8971A Noise Figure Test Set, and recommended LO) is used. Figures Ax.x are for amplifiers and transistors; Figures Bx.x are for mixers and receivers.

**Note:** The following graphs seem to show that the HP 8970B measures more accurately than the HP 8970T system. Keep in mind that the HP 8970T system eliminates many errors due to double sideband measurements. These errors are NOT accounted for in the HP 8970B accuracy calculation; it is assumed that the user completely eliminates these errors in the user's measurement system.

## Amplifier and Transistor Curves

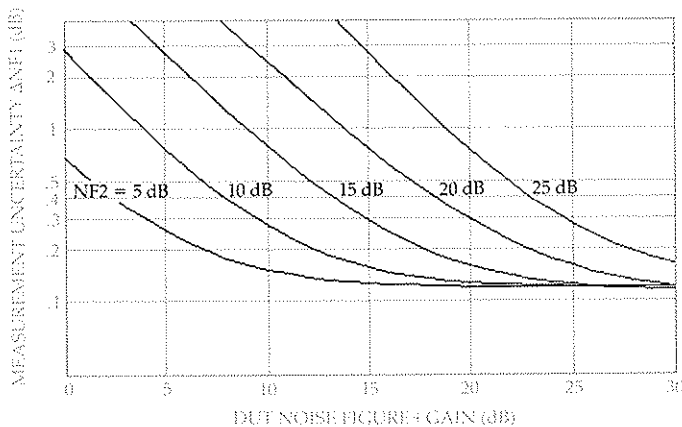

Figure A 1.1

Device under test: Amplifier or transistor  
 SWR input = 1.0  
 SWR output = 1.0

Measurement system: HP 8970A or 8970B  
 SWR in = 1.7  
 Noise figure instrumentation uncertainty = .1 dB  
 Gain instrumentation uncertainty = .15 dB

Noise source: HP 346  
 SWR out = 1.25  
 ENR uncertainty = .1 dB

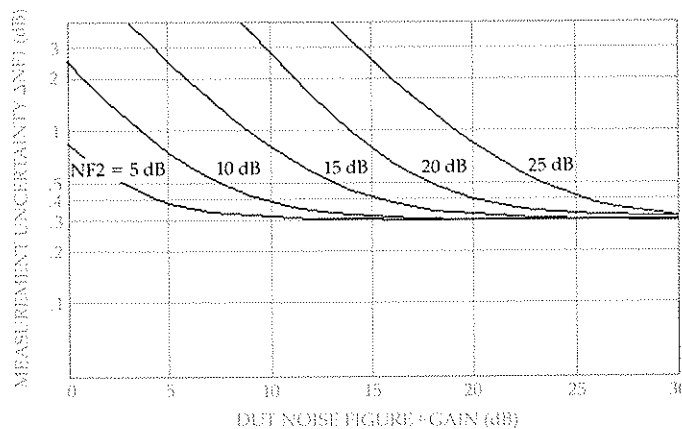
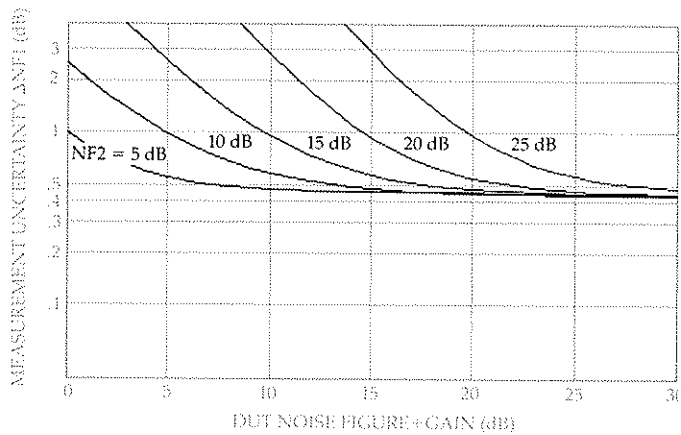

Figure A 1.2

Device under test: Amplifier or transistor  
 SWR input = 1.5  
 SWR output = 1.5

Measurement system: HP 8970A or 8970B  
 SWR in = 1.7  
 Noise figure instrumentation uncertainty = .1 dB  
 Gain instrumentation uncertainty = .15 dB

Noise source: HP 346  
 SWR out = 1.25  
 ENR uncertainty = .1 dB

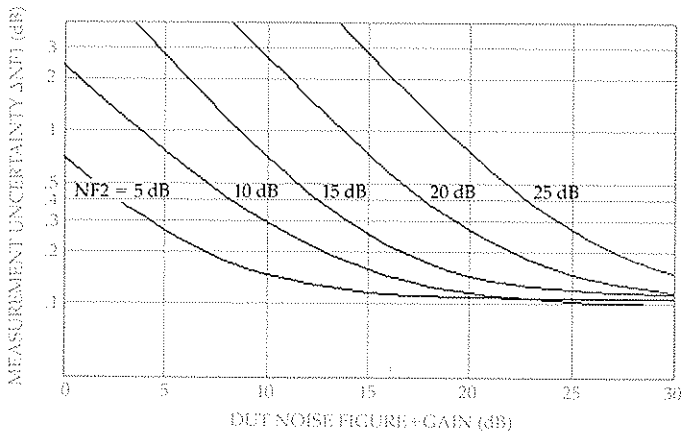

**Figure A 1.3**

Device under test: Amplifier or transistor  
 SWR input = 2.0  
 SWR output = 2.0

Measurement system: HP 8970A or 8970B  
 SWR in = 1.7  
 Noise figure instrumentation  
 uncertainty = .1 dB  
 Gain instrumentation  
 uncertainty = .15 dB

Noise source: HP 346  
 SWR out = 1.25  
 ENR uncertainty = .1 dB

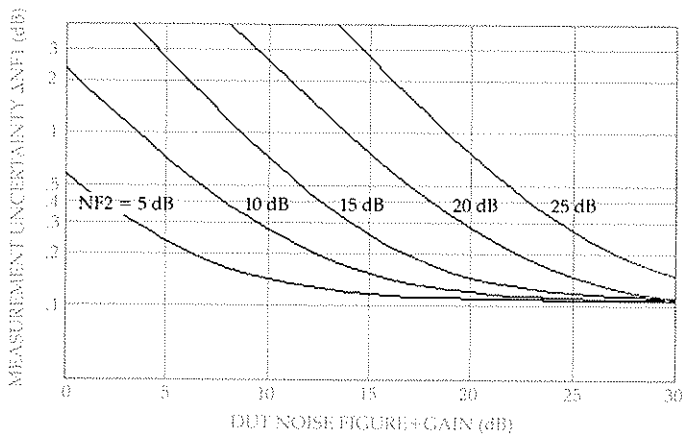

**Figure A 1.4**

Device under test: Amplifier or transistor  
 SWR input = 1.0  
 SWR output = 2.0

Measurement system: HP 8970A or 8970B  
 SWR in = 1.7  
 Noise figure instrumentation  
 uncertainty = .1 dB  
 Gain instrumentation  
 uncertainty = .15 dB

Noise source: HP 346  
 SWR out = 1.25  
 ENR uncertainty = .1 dB



**Figure A 2.1**

Device under test: Amplifier or transistor  
 SWR input = 1.0  
 SWR output = 1.0

Measurement system: HP 8970A or 8970B (with isolator)  
 SWR in = 1.2 (isolator SWR)  
 Noise figure instrumentation  
 uncertainty = .1 dB  
 Gain instrumentation  
 uncertainty = .15 dB

Noise figure: HP 346  
 SWR out = 1.25  
 ENR uncertainty = .1 dB

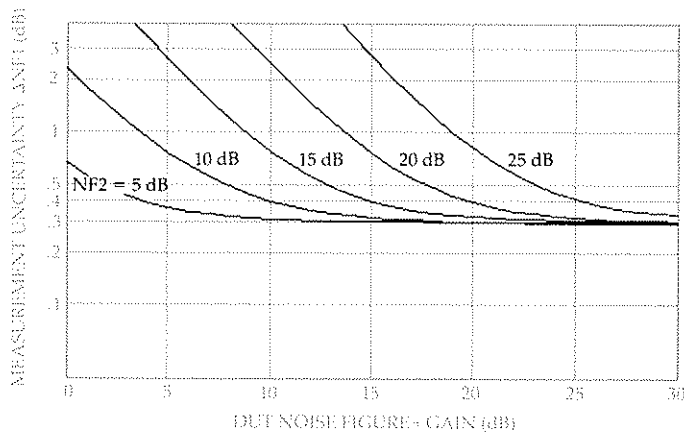

Figure A 2.2

Device under test: Amplifier or transistor  
 SWR input = 1.5  
 SWR output = 1.5

Measurement system: HP 8970A or 8970B (with isolator)  
 SWR in = 1.2 (isolator SWR)  
 Noise figure instrumentation uncertainty = .1 dB  
 Gain instrumentation uncertainty = .15 dB

Noise source: HP 346  
 SWR out = 1.25  
 ENR uncertainty = .1 dB

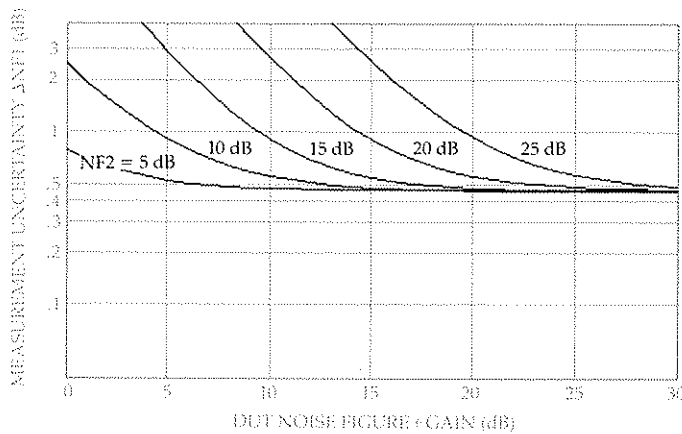

Figure A 2.3

Device under test: Amplifier or transistor  
 SWR input = 2.0  
 SWR output = 2.0

Measurement system: HP 8970A or 8970B (with isolator)  
 SWR in = 1.2 (isolator SWR)  
 Noise figure instrumentation uncertainty = .1 dB  
 Gain instrumentation uncertainty = .15 dB

Noise source: HP 346  
 SWR out = 1.25  
 ENR uncertainty = .1 dB

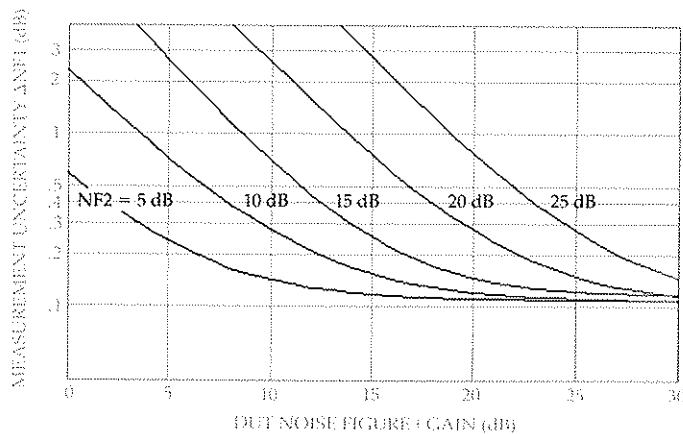

Figure A 2.4

Device under test: Amplifier or transistor  
 SWR input = 1.0  
 SWR output = 2.0

Measurement system: HP 8970A or 8970B (with isolator)  
 SWR in = 1.2 (isolator SWR)  
 Noise figure instrumentation uncertainty = .1 dB  
 Gain instrumentation uncertainty = .15 dB

Noise source: HP 346  
 SWR out = 1.25  
 ENR uncertainty = .1 dB

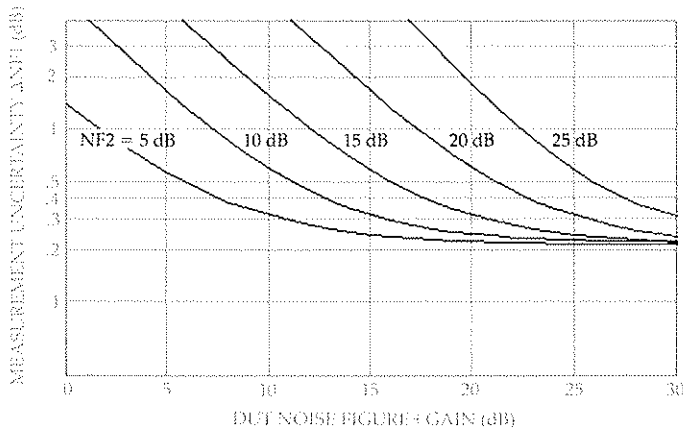

Figure A 3.1

Device under test: Amplifier or transistor  
 SWR input = 1.0  
 SWR output = 1.0

Measurement system: HP 8970T or HP 8970B, 8971B,  
 recommended LO  
 SWR in = 2.0  
 Noise figure instrumentation  
 uncertainty = .25 dB  
 Gain instrumentation  
 uncertainty = .45 dB

Noise source: HP 346  
 SWR out = 1.25  
 ENR uncertainty = .1 dB

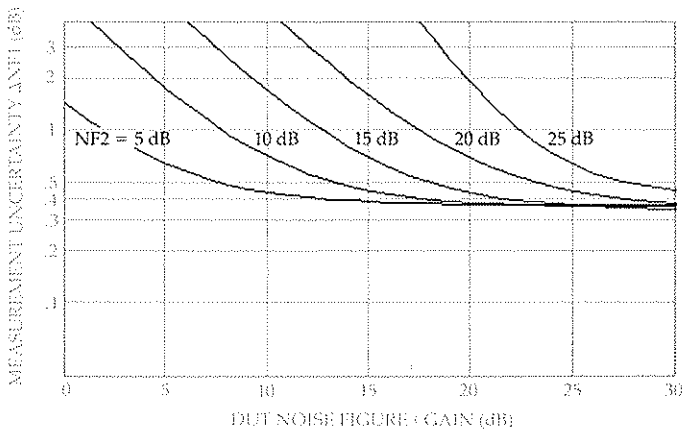

Figure A 3.2

Device under test: Amplifier or transistor  
 SWR input = 1.5  
 SWR output = 1.5

Measurement system: HP 8920T or HP 8970B, 8971B,  
 recommended LO  
 SWR in = 2.0  
 Noise figure instrumentation  
 uncertainty = .25 dB  
 Gain instrumentation  
 uncertainty = .45 dB

Noise source: HP 346  
 SWR out = 1.25  
 ENR uncertainty = .1 dB

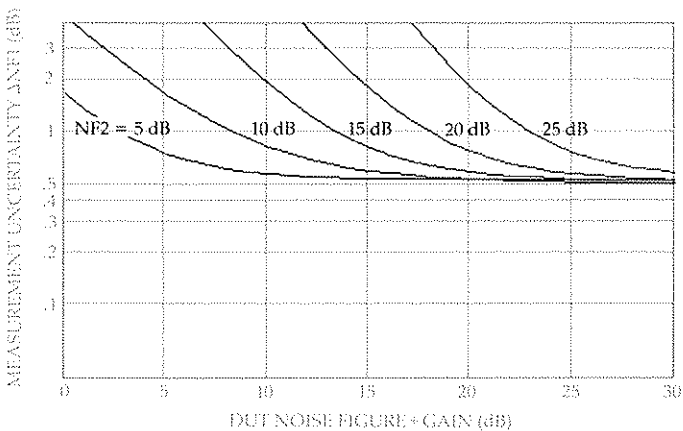
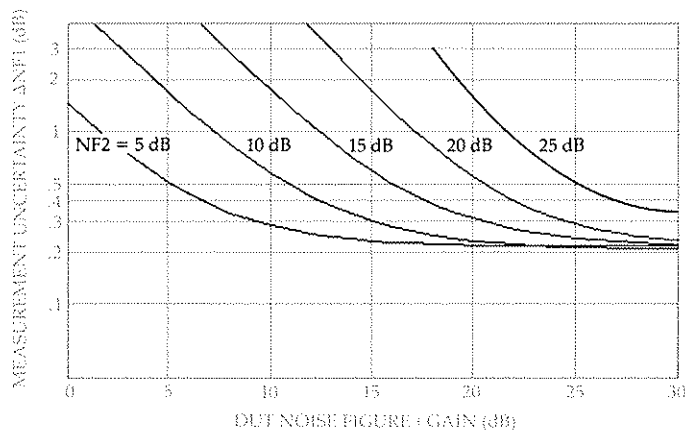

Figure A 3.3

Device under test: Amplifier or transistor  
 SWR input = 2.0  
 SWR output = 2.0

Measurement system: HP 8970T or HP 8970B, 8971B,  
 recommended LO  
 SWR in = 2.0  
 Noise figure instrumentation  
 uncertainty = .25 dB  
 Gain instrumentation  
 uncertainty = .45 dB

Noise source: HP 346  
 SWR out = 1.25  
 ENR uncertainty = .1 dB

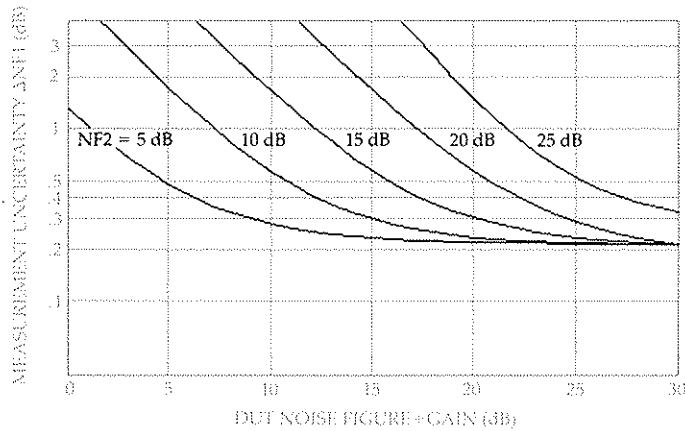

**Figure A 3.4**

Device under test: **Amplifier or transistor**  
 SWR input = 1.0  
 SWR output = 2.0

Measurement system: **HP 8970T or HP 8970B, 8971B, recommended LO**  
 SWR in = 2.0  
 Noise figure instrumentation uncertainty = .25 dB  
 Gain instrumentation uncertainty = .45 dB

Noise source: **HP 346**  
 SWR out = 1.25  
 ENR uncertainty = .1 dB

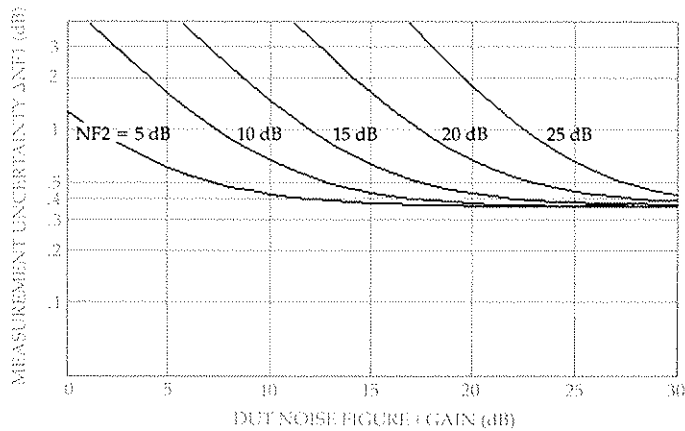

**Figure A 4.1**

Device under test: **Amplifier or transistor**  
 SWR input = 1.0  
 SWR output = 1.0

Measurement system: **HP 8970T or HP 8970B, 8971B, recommended LO; (with isolator)**  
 SWR in = 1.2 (isolator SWR)  
 Noise figure instrumentation uncertainty = .25 dB  
 Gain instrumentation uncertainty = .45 dB

Noise source: **HP 346**  
 SWR out = 1.25  
 ENR uncertainty = .1 dB



**Figure A 4.2**

Device under test: **Amplifier or transistor**  
 SWR input = 1.5  
 SWR output = 1.5

Measurement system: **HP 8970T or HP 8970B, 8971B, recommended LO; (with isolator)**  
 SWR in = 1.2 (isolator SWR)  
 Noise figure instrumentation uncertainty = .25 dB  
 Gain instrumentation uncertainty = .45 dB

Noise source: **HP 346**  
 SWR out = 1.25  
 ENR uncertainty = .1 dB

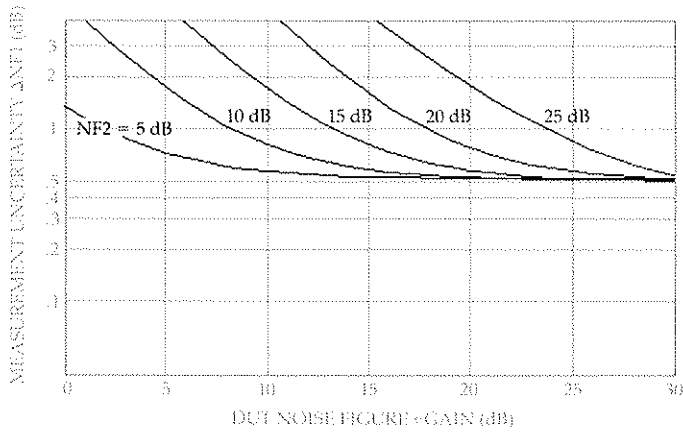

Figure A 4.3

Device under test: Amplifier or transistor  
 SWR input = 2.0  
 SWR output = 2.0

Measurement system: HP 8970T or HP 8970B, 8971B,  
 recommended LO; (with isolator)  
 SWR in = 1.2 (isolator SWR)  
 Noise figure instrumentation  
 uncertainty = .25 dB  
 Gain instrumentation  
 uncertainty = .45 dB

Noise source: HP 346  
 SWR out = 1.25  
 ENR uncertainty = .1 dB

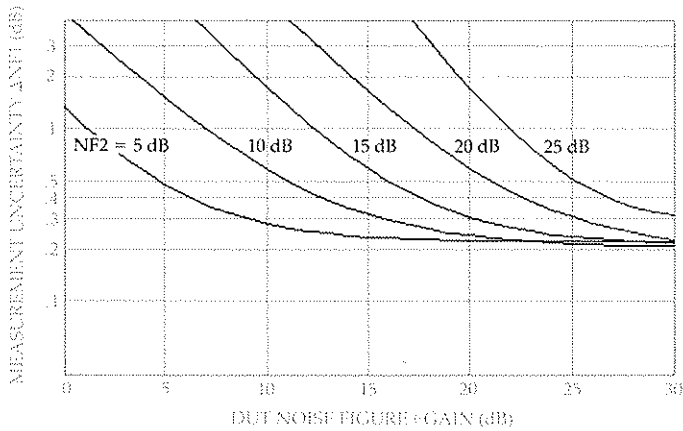

Figure A 4.4

Device under test: Amplifier or transistor  
 SWR input = 1.0  
 SWR output = 2.0

Measurement system: HP 8970T or HP 8970B, 8971B,  
 recommended LO; (with isolator)  
 SWR in = 1.2 (isolator SWR)  
 Noise figure instrumentation  
 uncertainty = .25 dB  
 Gain instrumentation  
 uncertainty = .45 dB

Noise source: HP 346  
 SWR out = 1.25  
 ENR uncertainty = .1 dB

## Mixer and Receiver Curves

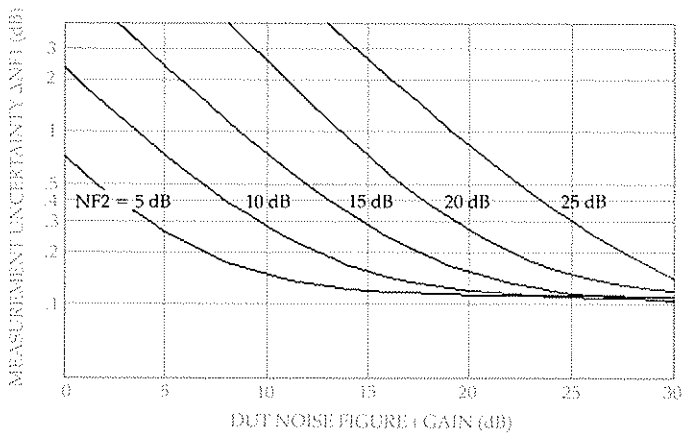
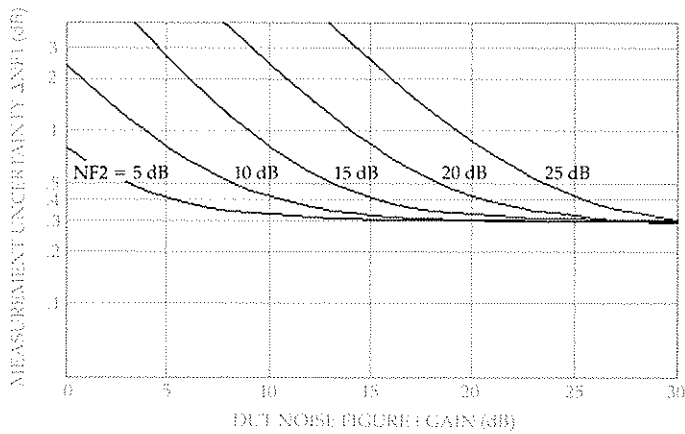

Figure B 1.1

Device under test: Mixer or receiver  
 SWR input = 1.0  
 SWR output = 1.0

Measurement system: HP 8970A or HP 8970B  
 SWR in = 1.7  
 Noise figure instrumentation  
 uncertainty = .1 dB  
 Gain instrumentation  
 uncertainty = .15 dB

Noise source: HP 346  
 SWR out = 1.25  
 ENR uncertainty = .1 dB

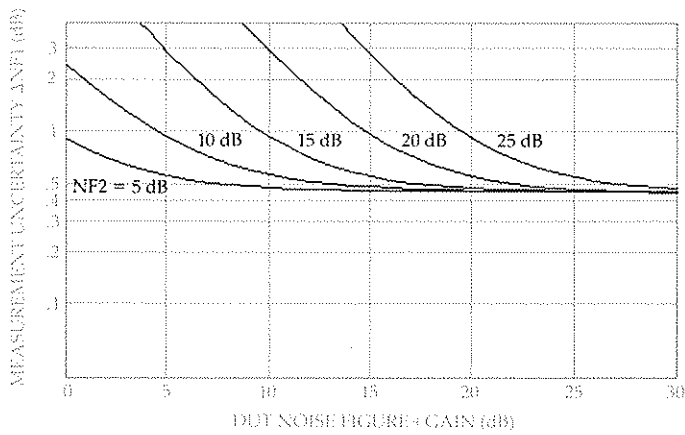

**Figure B 1.2**

Device under test: Mixer or receiver  
 SWR input = 1.5  
 SWR output = 1.5

Measurement system: HP 8970A or HP 8970B  
 SWR in = 1.7  
 Noise figure instrumentation uncertainty = .1 dB  
 Gain instrumentation uncertainty = .15 dB

Noise source: HP 346  
 SWR out = 1.25  
 ENR uncertainty = .1 dB

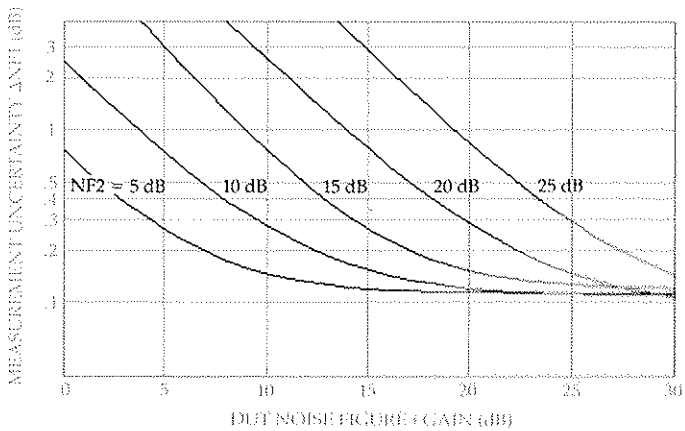

**Figure B 1.3**

Device under test: Mixer or receiver  
 SWR input = 2.0  
 SWR output = 2.0

Measurement system: HP 8970A or HP 8970B  
 SWR in = 1.7  
 Noise figure instrumentation uncertainty = .1 dB  
 Gain instrumentation uncertainty = .15 dB

Noise source: HP 346  
 SWR out = 1.25  
 ENR uncertainty = .1 dB



**Figure B 1.4**

Device under test: Mixer or receiver  
 SWR input = 1.0  
 SWR output = 2.0

Measurement system: HP 8970A or HP 8970B  
 SWR in = 1.7  
 Noise figure instrumentation uncertainty = .1 dB  
 Gain instrumentation uncertainty = .15 dB

Noise source: HP 346  
 SWR out = 1.25  
 ENR uncertainty = .1 dB



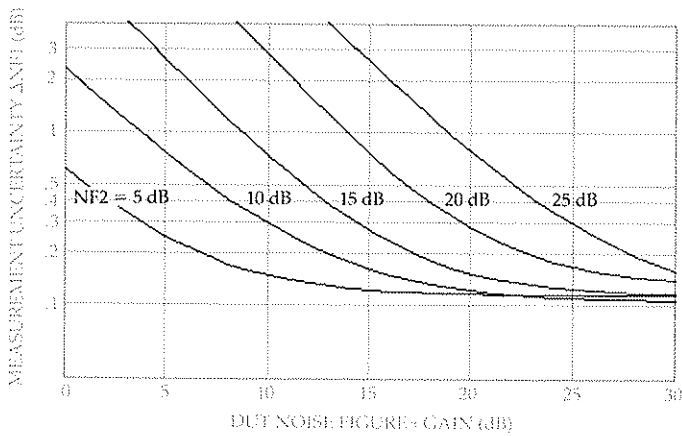

Figure B 2.1

Device under test: Mixer or receiver  
 SWR input = 1.0  
 SWR output = 1.0

Measurement system: HP 8970A or HP 8970B;  
 (with isolator)  
 SWR in = 1.2 (isolator SWR)  
 Noise figure instrumentation  
 uncertainty = .1 dB  
 Gain instrumentation  
 uncertainty = .15 dB

Noise source: HP 346  
 SWR out = 1.25  
 ENR uncertainty = .1 dB

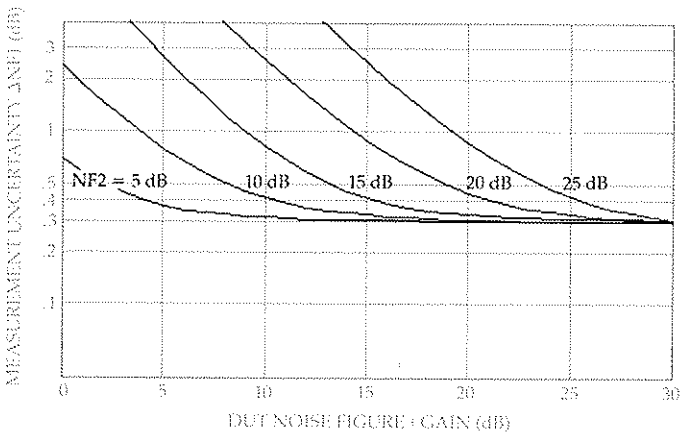

Figure B 2.2

Device under test: Mixer or receiver  
 SWR input = 1.5  
 SWR output = 1.5

Measurement system: HP 8970A or HP 8970B;  
 (with isolator)  
 SWR in = 1.2 (isolator SWR)  
 Noise figure instrumentation  
 uncertainty = .1 dB  
 Gain instrumentation  
 uncertainty = .15 dB

Noise source: HP 346  
 SWR out = 1.25  
 ENR uncertainty = .1 dB

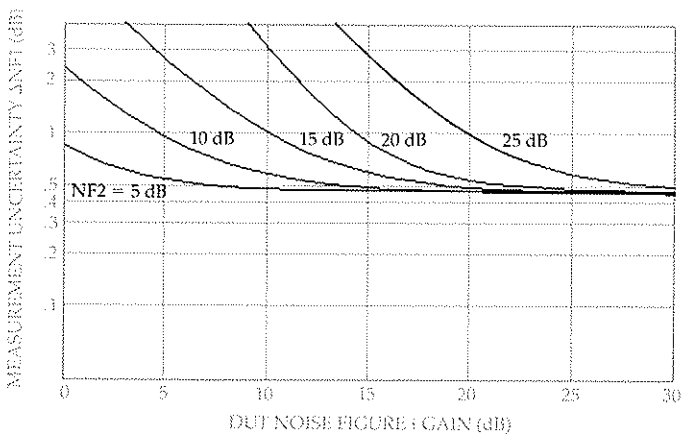

Figure B 2.3

Device under test: Mixer or receiver  
 SWR input = 2.0  
 SWR output = 2.0

Measurement system: HP 8970A or HP 8970B;  
 (with isolator)  
 SWR in = 1.2 (isolator SWR)  
 Noise figure instrumentation  
 uncertainty = .1 dB  
 Gain instrumentation  
 uncertainty = .15 dB

Noise source: HP 346  
 SWR out = 1.25  
 ENR uncertainty = .1 dB

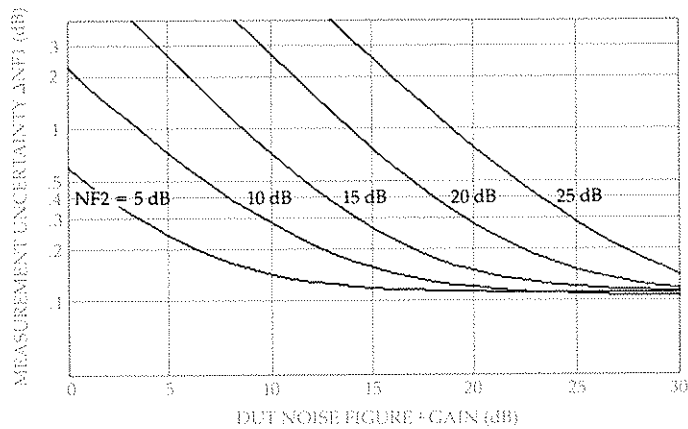

Figure B 2.4

Device under test: Mixer or receiver  
 SWR input = 1.0  
 SWR output = 2.0

Measurement system: HP 8970A or HP 8970B;  
 (with isolator)  
 SWR in = 1.2 (isolator SWR)  
 Noise figure instrumentation  
 uncertainty = .1 dB  
 Gain instrumentation  
 uncertainty = .15 dB

Noise source: HP 346  
 SWR out = 1.25  
 ENR uncertainty = .1 dB

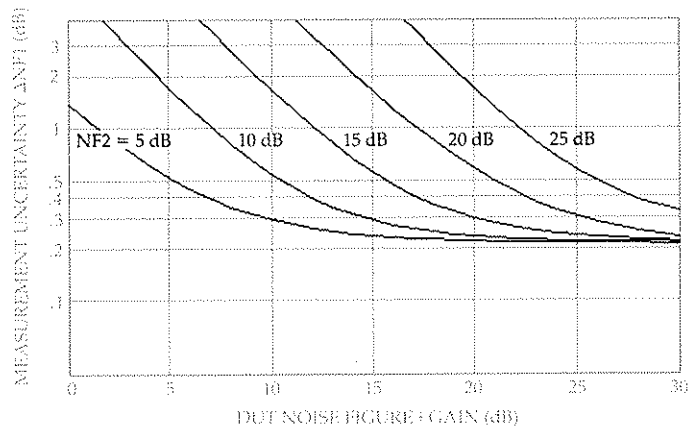

Figure B 3.1

Device under test: Mixer or receiver  
 SWR input = 1.0  
 SWR output = 1.0

Measurement system: HP 8970T or HP 8970B, 8971B,  
 recommended LO  
 SWR in = 2.0  
 Noise figure instrumentation  
 uncertainty = .25 dB  
 Gain instrumentation  
 uncertainty = .45 dB

Noise source: HP 346  
 SWR out = 1.25  
 ENR uncertainty = .1 dB

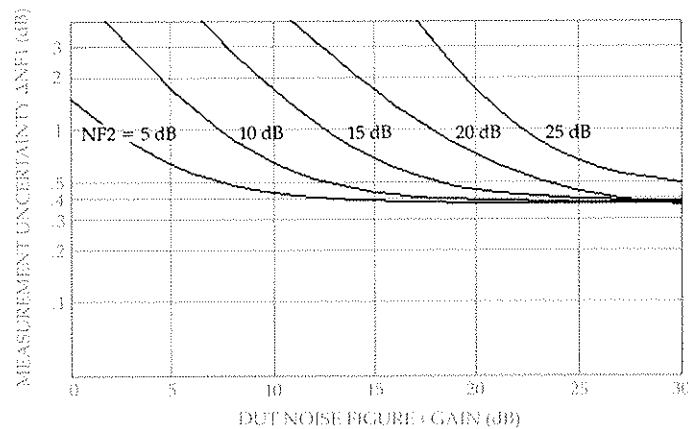

Figure B 3.2

Device under test: Mixer or receiver  
 SWR input = 1.5  
 SWR output = 1.5

Measurement system: HP 8970T or HP 8970B, 8971B,  
 recommended LO  
 SWR in = 2.0  
 Noise figure instrumentation  
 uncertainty = .25 dB  
 Gain instrumentation  
 uncertainty = .45 dB

Noise source: HP 346  
 SWR out = 1.25  
 ENR uncertainty = .1 dB

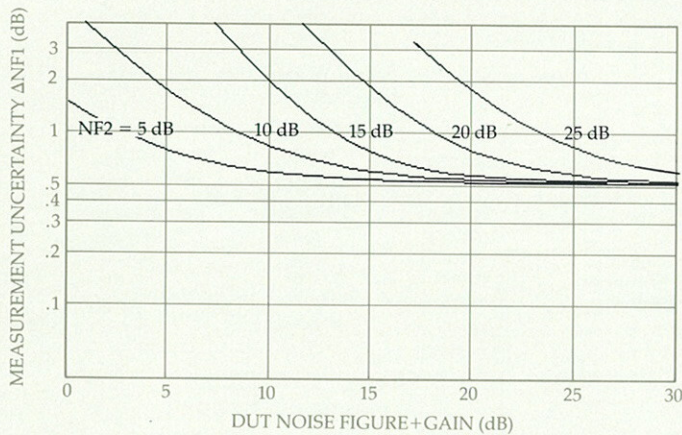

Figure B 3.3

Device under test: Mixer or receiver  
 SWR input = 2.0  
 SWR output = 2.0

Measurement system: HP 8970T or HP 8970B, 8971B,  
 recommended LO  
 SWR in = 2.0  
 Noise figure instrumentation  
 uncertainty = .25 dB  
 Gain instrumentation  
 uncertainty = .45 dB

Noise source: HP 346  
 SWR out = 1.25  
 ENR uncertainty = .1 dB

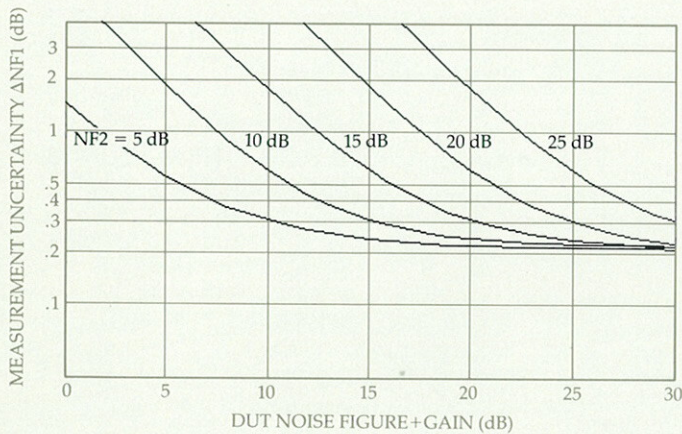

Figure B 3.4

Device under test: Mixer or receiver  
 SWR input = 1.0  
 SWR output = 2.0

Measurement system: HP 8970T or HP 8970B, 8971B,  
 recommended LO  
 SWR in = 2.0  
 Noise figure instrumentation  
 uncertainty = .25 dB  
 Gain instrumentation  
 uncertainty = .45 dB

Noise source: HP 346  
 SWR out = 1.25  
 ENR uncertainty = .1 dB

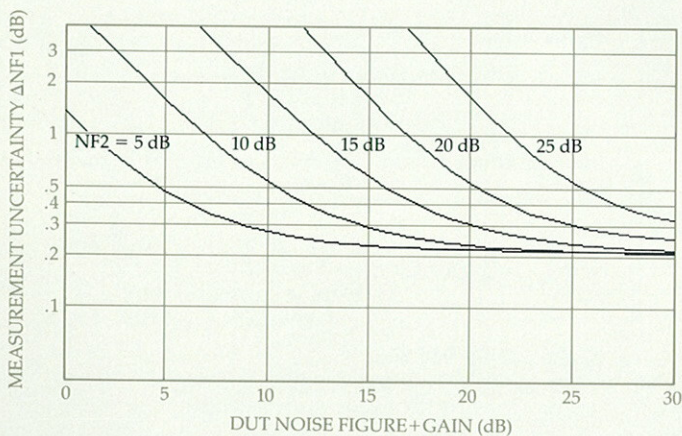

Figure B 4.1

Device under test: Mixer or receiver  
 SWR input = 1.0  
 SWR output = 1.0

Measurement system: HP 8970T or HP 8970B, 8971B,  
 recommended LO; (with isolator)  
 SWR in = 1.2 (isolator SWR)  
 Noise figure instrumentation  
 uncertainty = .25 dB  
 Gain instrumentation  
 uncertainty = .45 dB

Noise source: HP 346  
 SWR out = 1.25  
 ENR uncertainty = .1 dB

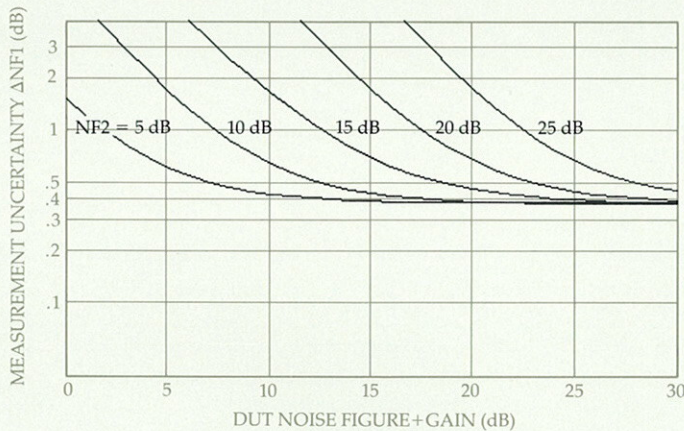

Figure B 4.2

Device under test: Mixer or receiver  
 SWR input = 1.5  
 SWR output = 1.5

Measurement system: HP 8970T or HP 8970B, 8971B,  
 recommended LO; (with isolator)  
 SWR in = 1.2 (isolator SWR)  
 Noise figure instrumentation  
 uncertainty = .25 dB  
 Gain instrumentation  
 uncertainty = .45 dB

Noise source: HP 346  
 SWR out = 1.25  
 ENR uncertainty = .1 dB

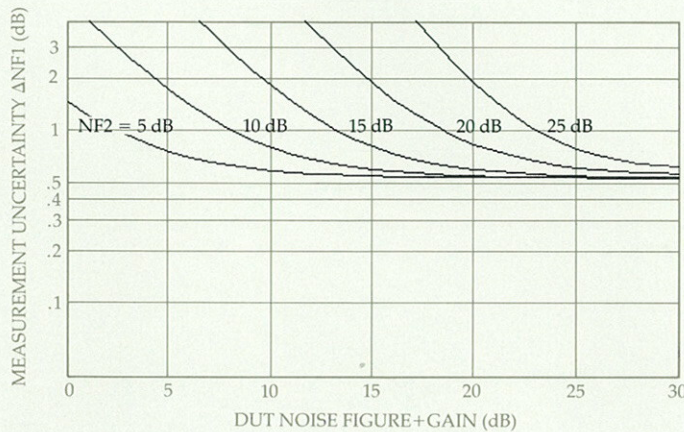

Figure B 4.3

Device under test: Mixer or receiver  
 SWR input = 2.0  
 SWR output = 2.0

Measurement system: HP 8970T or HP 8970B, 8971B,  
 recommended LO; (with isolator)  
 SWR in = 1.2 (isolator SWR)  
 Noise figure instrumentation  
 uncertainty = .25 dB  
 Gain instrumentation  
 uncertainty = .45 dB

Noise source: HP 346  
 SWR out = 1.25  
 ENR uncertainty = .1 dB

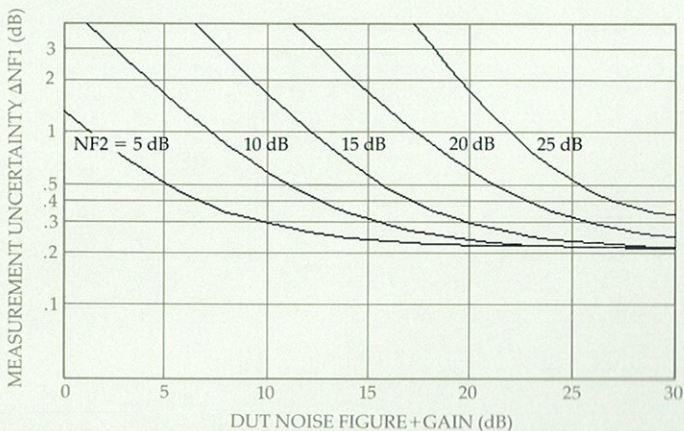

Figure B 4.4

Device under test: Mixer or receiver  
 SWR input = 1.0  
 SWR output = 2.0

Measurement system: HP 8970T or HP 8970B, 8971B,  
 recommended LO; (with isolator)  
 SWR in = 1.2 (isolator SWR)  
 Noise figure instrumentation  
 uncertainty = .25 dB  
 Gain instrumentation  
 uncertainty = .45 dB

Noise source: HP 346  
 SWR out = 1.25  
 ENR uncertainty = .1 dB

For more information, call your local HP sales office listed in the telephone directory white pages. Ask for the Test and Measurements Department, or write to Hewlett-Packard:

**United States**  
Hewlett-Packard  
P.O. Box 10301  
Palo Alto, CA 94303-0890

**Canada**  
Hewlett-Packard Ltd.  
6877 Goreway Drive  
Mississauga, L4V 1M8 Ontario

**Europe, Africa, Middle East**  
Central Mailing Dept.  
P.O. Box 529  
1180 AM Amstelveen  
The Netherlands

**Japan**  
Yokogawa-Hewlett-Packard Ltd.  
3-29-21 Takaido-Higashi  
Suginami-ku, Tokyo 168

**Elsewhere in the world, write to:**  
Hewlett-Packard Company  
Intercontinental Headquarters  
3495 Deer Creek Road  
Palo Alto, CA 94304-1393 U.S.A.

Data Subject to Change  
November 1988

Printed in U.S.A.  
5952-3706

